

DIMORE

MASIERO



DIMORE

MASIERO

Collections



Cordea

34

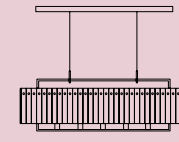

Crek

214

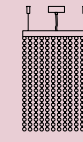

Cubo

226



Ebe

68

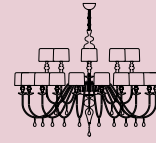

Eva

246

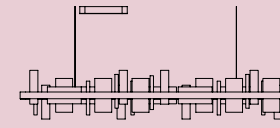

Honicé

144



Horo

108

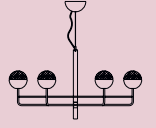

Iglù

94

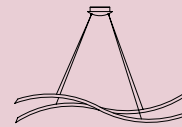

Libe

290



Nappe

158

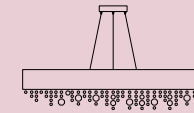

Olà

180



Palm

302

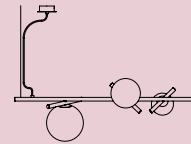

Posy

78

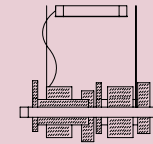

Ribbon

202

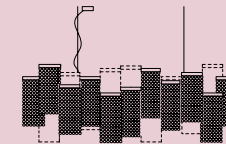

Skyline

314

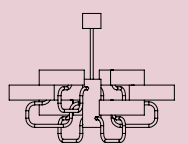

Sound

260

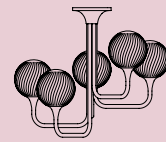

Tee

50



Timeo

280



Vegas

124

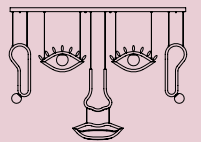

Visio

16



Vollee

322

Suspension



Cordea

34

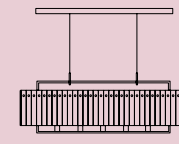

Crek

214

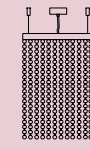

Cubo

226

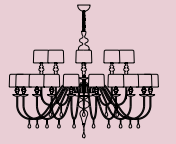

Eva

246

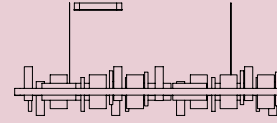

Honicé

144



Horo

108

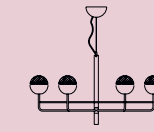

Iglù

94

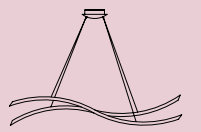

Libe

290



Nappe

158

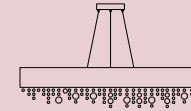

Olà

180

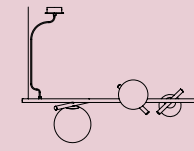

Posy

78

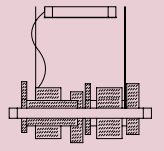

Ribbon

202

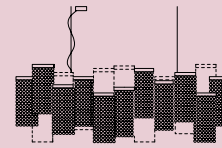

Skyline

314

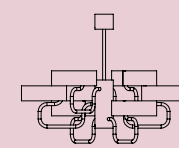

Sound

260



Tee

50



Timeo

280



Vegas

124

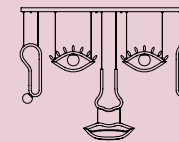

Visio

16

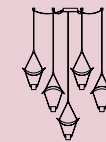

Vollee

322

Applique

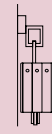

Crek
214



Cubo
226



Ebe
68

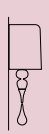

Eva
246

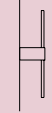

Honicé
144



Horo
108



Iglù
94

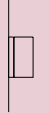

Libe
290

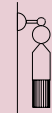

Nappe
158

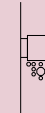

Olà
180



Palm
302



Posy
78

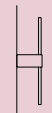

Ribbon
202



Skyline
314



Sound
260



Tee
50



Timeo
280



Vegas
124

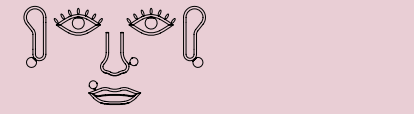

Visio
16

Ceiling

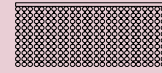

Cubo
226



Iglù
94

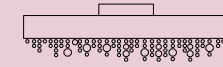

Olà
180

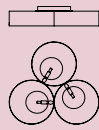

Sound
260

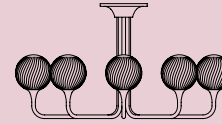

Tee
50

Table

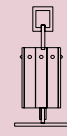

Crek
214



Ebe
68

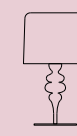

Eva
246

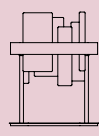

Honicé
144



Horo
108



Iglù
94



Libe
290

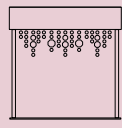

Olà
180

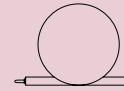

Posy
78

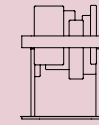

Ribbon
202



Sound
260



Tee
50



Timeo
280



Vegas
124



Visio
16

Floor

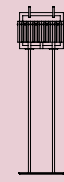

Crek
214



Ebe
68



Eva
246



Honicé
144



Horo
108



Iglù
94



Olà
180



Posy
78



Ribbon
202



Sound
260



Tee
50



Timeo
280



Vegas
124

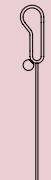

Visio
16

Collections



Visio

IT Un echeggiare di richiami al mondo surrealista, strati di significato da scoprire a uno a uno nelle tante diverse configurazioni possibili delle geometrie facciali di Visio, un inno all'apparato iconografico e all'espressività del volto. Un vocabolario estetico, quello di Visio, in cui l'unione di misticismo e geometria creano variazioni imprevedibili sul tema dell'immaginazione.

EN An echo of allusions to the Surrealist world, layers of meaning to be discovered one by one in the many different possible configurations of Visio's facial geometries, an homage to the iconographic apparatus and expressiveness of the face. An aesthetic vocabulary, one of Visio, where the union of mysticism and geometry creates unpredictable variations on the theme of imagination.

DESIGN BY
NAVA + AROSIO

SUSPENSION
APPLIQUE
TABLE LAMP
FLOOR LAMP

VISIO S
COMPOSITION













VISIO TL M1



VISIO S M2
COMPOSITION



Visio

Struttura in metallo verniciato.
Diffusore in vetro triplex di Murano
bianco opalino. Illuminazione a Led.

Painted metal structure. Opal white
Murano triplex glass diffuser. LED
lighting.

Gestell aus lackiertem Metall.
Schirm aus weissem Triplex-
Opalglas aus Murano. LED-
Leuchtmittel.

Estructura en metal pintado.
Difusor de vidrio triplex de Murano
blanco opalino. Iluminación led.

Structure en métal laqué. Diffuseur
en verre triplex de Murano opale
blanc. Éclairage LED.

Каркас из окрашенного металла.
Плафоны из белого опалового
муранского стекла триплекс.
Светодиодное освещение.

涂色金属灯体结构。蛋白石白色穆拉
诺三层玻璃灯罩。Led照明。

هيكل معدني مطلي. ناشر ضوء من زجاج ثلاثي
أبيض مورانو أوبال. إضاءة ليد.

VISIO S FULL	
L	182 cm / 71.70"
SP	12 cm / 4.70"
H	99 cm / 39.00"
INTEGRATED LED LIGHTING	
32,6 W CRI>90	
3000 K – 3673 NOMINAL LM	

DIMM 1-10V + PUSH

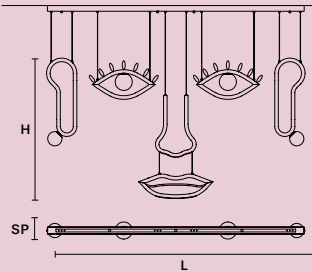

VISIO S 1/2	
L	117 cm / 46.10"
SP	12 cm / 4.70"
H	99 cm / 39.00"
INTEGRATED LED LIGHTING	
21,6 W CRI>90	
3000 K – 2383 NOMINAL LM	

DIMM 1-10V + PUSH

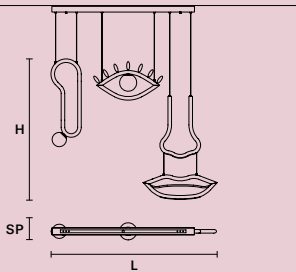

VISIO S M1	
L	48 cm / 18.90"
SP	12 cm / 4.70"
H	27 cm / 10.60"
INTEGRATED LED LIGHTING	
5,5 W CRI>90	
3000 K – 645 NOMINAL LM	

DIMM NO

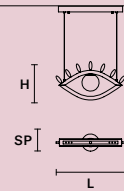

VISIO A M2 SX	
L	22 cm / 8.70"
SP	16 cm / 6.30"
H	61 cm / 24.00"
INTEGRATED LED LIGHTING	
5,5 W CRI>90	
3000 K – 645 NOMINAL LM	

DIMM NO

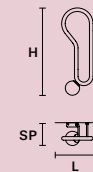

VISIO A M2 DX	
L	22 cm / 8.70"
SP	16 cm / 6.30"
H	61 cm / 24.00"
INTEGRATED LED LIGHTING	
5,5 W CRI>90	
3000 K – 645 NOMINAL LM	

DIMM NO



VISIO A M3	
L	37.5 cm / 14.80"
SP	12 cm / 4.70"
H	43 cm / 16.90"
INTEGRATED LED LIGHTING	
4,6 W CRI>90	
3000 K – 478 NOMINAL LM	

DIMM NO

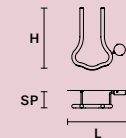

VISIO A M4	
L	52 cm / 20.50"
SP	12 cm / 4.70"
H	24 cm / 9.40"
INTEGRATED LED LIGHTING	
6 W CRI>90	
3000 K – 615 NOMINAL LM	

DIMM NO



VISIO S M2	
L	28 cm / 11.00"
SP	10 cm / 3.90"
H	61 cm / 24.00"
INTEGRATED LED LIGHTING	
5,5 W CRI>90	
3000 K – 645 NOMINAL LM	

DIMM NO

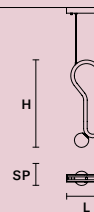

VISIO S M4	
L	52 cm / 20.50"
SP	5 cm / 2.00"
H	18 cm / 7.10"
INTEGRATED LED LIGHTING	
6 W CRI>90	
3000 K – 615 NOMINAL LM	

DIMM NO



VISIO A FULL	
L	182 cm / 71.70"
SP	17 cm / 6.70"
H	99 cm / 39.00"
INTEGRATED LED LIGHTING	
32,6 W CRI>90	
3000 K – 3673 NOMINAL LM	

DIMM NO

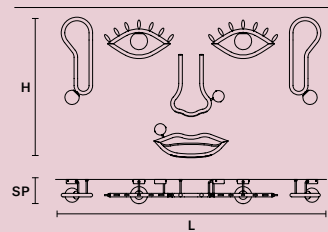

VISIO TL M1	
L	48 cm / 18.90"
SP	25.5 cm / 10.00"
H	70 cm / 27.60"
INTEGRATED LED LIGHTING	
5,5 W CRI>90	
3000 K – 645 NOMINAL LM	

DIMM OWN BUTTON

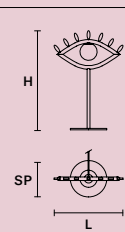

VISIO TL M4	
L	52 cm / 20.50"
SP	25.5 cm / 10.00"
H	60 cm / 23.60"
INTEGRATED LED LIGHTING	
5,3 W CRI>90	
3000 K – 546,6 NOMINAL LM	

DIMM OWN BUTTON

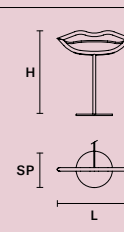

VISIO STL M1	
L	48 cm / 18.90"
SP	32 cm / 12.60"
H	166.5 cm / 65.60"
INTEGRATED LED LIGHTING	
5,5 W CRI>90	
3000 K – 645 NOMINAL LM	

DIMM OWN BUTTON

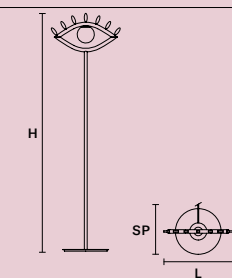

VISIO STL M2	
ø	32 cm / 12.60"
H	166 cm / 65.40"
INTEGRATED LED LIGHTING	
5,5 W CRI>90	
3000 K – 645 NOMINAL LM	

DIMM OWN BUTTON

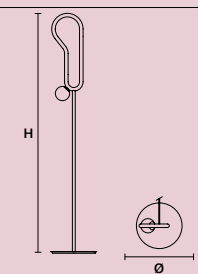

VISIO A SX	
L	117 cm / 46.10"
SP	17 cm / 6.70"
H	99 cm / 39.00"
INTEGRATED LED LIGHTING	
21,6 W CRI>90	
3000 K – 2383 NOMINAL LM	

DIMM NO

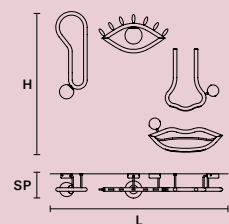

VISIO A DX	
L	117 cm / 46.10"
SP	17 cm / 6.70"
H	99 cm / 39.00"
INTEGRATED LED LIGHTING	
21,6 W CRI>90	
3000 K – 2383 NOMINAL LM	

DIMM NO

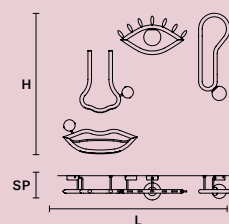

VISIO A M1	
L	48 cm / 18.90"
SP	17 cm / 6.70"
H	27 cm / 10.60"
INTEGRATED LED LIGHTING	
5,5 W CRI>90	
3000 K – 645 NOMINAL LM	

DIMM NO

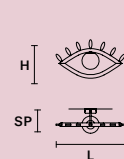

VISIO STL M3	
ø	32 cm / 12.60"
H	155 cm / 61.00"
INTEGRATED LED LIGHTING	
4 W CRI>90	
3000 K – 410 NOMINAL LM	

DIMM OWN BUTTON

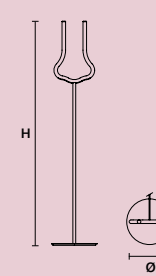

VISIO STL M4	
L	52 cm / 20.50"
SP	32 cm / 12.60"
H	129 cm / 50.80"
INTEGRATED LED LIGHTING	
5,3 W CRI>90	
3000 K – 546,6 NOMINAL LM	

DIMM OWN BUTTON

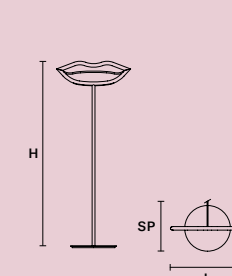

For the US market, refer to the relevant price list.

VISIO C3 M1 RD 60 

∅ 60 cm / 23.60"
H MAX 150 cm / 59.10"

INTEGRATED LED LIGHTING
16,5 W CRI>90
3000 K – 1935 NOMINAL LM

DIMM 1-10V + PUSH

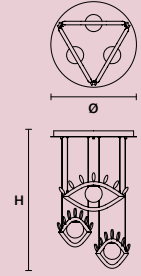

VISIO C3 M2 RD 40 

∅ 40 cm / 15.70"
H MAX 150 cm / 59.10"

INTEGRATED LED LIGHTING
16,5 W CRI>90
3000 K – 1935 NOMINAL LM

DIMM 1-10V + PUSH



VISIO C5 RD 80 

∅ 80 cm / 31.50"
H MAX 150 cm / 59.10"

INTEGRATED LED LIGHTING
27,5 W CRI>90
3000 K – 3225 NOMINAL LM

DIMM 1-10V + PUSH

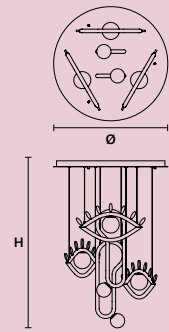

Cordea

IT Cordea nasce dal desiderio di reinterpretare la classica lampada industriale a testa lamellare in alluminio, in chiave contemporanea sotto il punto di vista estetico e materico. Il telaio in metallo sapientemente forgiato è caratterizzato da un cinturino in cuoio a contrasto.

EN Cordea was born out of the desire to reinterpret the classic industrial lamp with an aluminium lamellar head in a contemporary way, from an aesthetic and material perspective. The expertly forged metal frame features a contrasting leather strap.

CORDEA S
COMPOSITION

DESIGN BY
FAVARETTO/PARTNERS

SUSPENSION











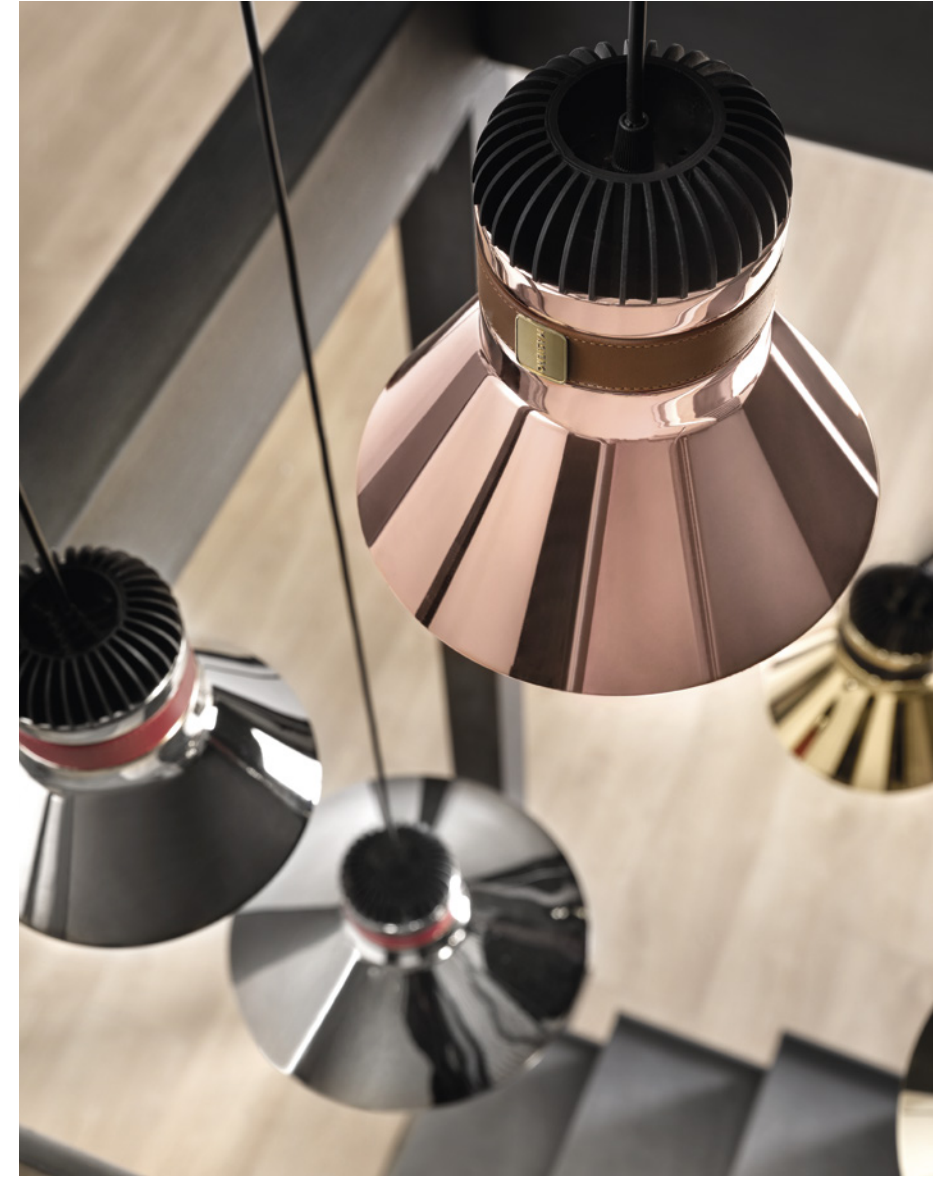

Cordea

Struttura in metallo galvanizzato decorata con cinturino in cuoio. Diffusore in vetro satinato bianco. Illuminazione a Led.

Galvanised metal structure decorated with a leather strap. White frosted glass diffuser. LED lighting.

Gestell aus galvanisch beschichtetem Metall verziert mit einem Lederband. Schirm aus weissem satiniertem Glas. LED-Leuchtmittel.

Estructura de metal galvanizado decorada con correa de cuero. Difusor de vidrio satinado blanco. Iluminación Led.

Structure en métal galvanisé décorée d'un bracelet en caoutchouc. Diffuseur en verre satiné blanc. Éclairage LED.

Каркас из оцинкованного металла, декор - кольцо из кожи. Плафон из белого сатирированного стекла. Светодиодное освещение.

饰有皮革条带的镀锌金属灯体结构。白色磨砂玻璃灯罩。Led照明。

هيكل معدني مجلفن مزين بحزام جلدي صغير. ناشر ضوء من الزجاج المصقول الأبيض. إضاءة ليد.

CORDEA S P

ø 22 cm / 8.70"
H 19 cm / 7.50"

INTEGRATED LED LIGHTING
10 W CRI>90
3000 K – 1510 NOMINAL LM

DIMM NO

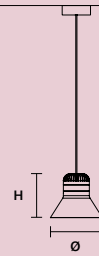

CORDEA S G

ø 36 cm / 14.20"
H 16 cm / 6.30"

INTEGRATED LED LIGHTING
10 W CRI>90
3000 K – 1510 NOMINAL LM

DIMM NO

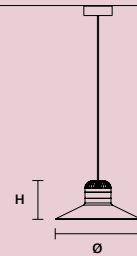

BAND FINISHING



G22 Oro
Pure gold



BL1 Black leather



G23 Nickel scuro
Dark nickel



BL2 Brown leather



G24 Oro rosa
Rose gold



BL3 Red leather

CORDEA C3 RD 40

ø 50 cm / 19.70"
H MAX 170 cm / 67.00"

INTEGRATED LED LIGHTING
30 W CRI>90
3000 K – 4530 NOMINAL LM

DIMM 1-10V + PUSH

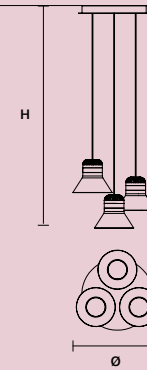

CORDEA C3 RD 60

ø 60 cm / 23.60"
H MAX 170 cm / 67.00"

INTEGRATED LED LIGHTING
30 W CRI>90
3000 K – 4530 NOMINAL LM

DIMM 1-10V + PUSH

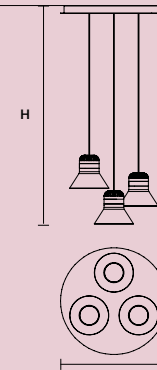

CORDEA C5 RD 80

ø 80 cm / 31.50"
H MAX 170 cm / 67.00"

INTEGRATED LED LIGHTING
50 W CRI>90
3000 K – 7550 NOMINAL LM

DIMM 1-10V + PUSH + DALI

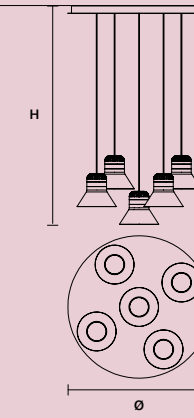

CORDEA C3 LN 75

L 75 cm / 29.50"
SP 22 cm / 8.70"
H MAX 170 cm / 67.00"

INTEGRATED LED LIGHTING
30 W CRI>90
3000 K – 4530 NOMINAL LM

DIMM 1-10V + PUSH

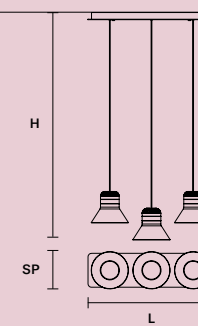

CORDEA C3 LN 125

L 125 cm / 49.20"
SP 22 cm / 8.70"
H MAX 170 cm / 67.00"

INTEGRATED LED LIGHTING
30 W CRI>90
3000 K – 4530 NOMINAL LM

DIMM 1-10V + PUSH

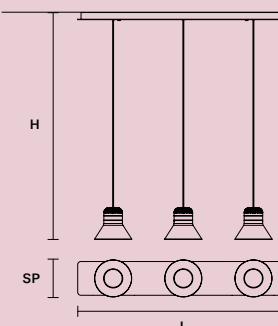

CORDEA C5 LN 175

L 175 cm / 68.90"
SP 22 cm / 8.70"
H MAX 170 cm / 67.00"





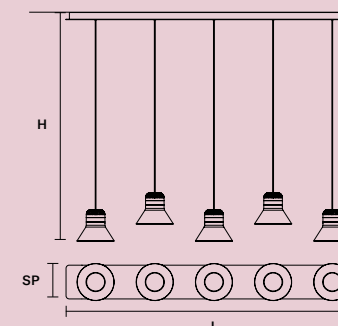







INTEGRATED LED LIGHTING
50 W CRI>90
3000 K – 7550 NOMINAL LM

DIMM 1-10V + PUSH + DALI



For the US market, refer to the relevant price list.

Finishings

BAND	FRAME*		
BL1 Black leather	G22 Oro Pure gold	G23 Nickel scuro Dark nickel	G24 Oro rosa Rose gold
			
BL2 Brown leather	G22 Oro Pure gold	G23 Nickel scuro Dark nickel	G24 Oro rosa Rose gold
			
BL3 Red leather	G22 Oro Pure gold	G23 Nickel scuro Dark nickel	G24 Oro rosa Rose gold
			

* Internal side V10 Beige

Tee

IT Tee è un esercizio progettuale di ricerca tra rigore geometrico ed eleganza, contrassegnato esteticamente dalla linea curva. Sfere luminose animate da linee che richiamano la natura ondulatoria della luce e raccordate su steli curvati a foglia organica, ricordano la delicatezza del fiore di calla.

EN Tee is an exploratory design exercise which balances rigour and elegance, aesthetically distinguished by its curved form. Light spheres are brought to life by contours that reflect the undulating nature of light, connected on organically shaped stems, reminiscent of the gracefulness of the calla lily flower.

DESIGN BY
VALERIO COMETTI
+V12DESIGN

SUSPENSION
CEILING
APPLIQUE
TABLE LAMP
FLOOR LAMP

TEE PL5







TEE STL3



TEE STL3 LIGHT OFF



TEE S1
COMPOSITION



TEE TL1 20



TEE STL1
TEE A1 20



TEE PL 5+5 RD 120



Tee

Struttura in metallo galvanizzato.
Diffusori in vetro triplex di Murano.
Illuminazione tradizionale.

Galvanised metal structure. Murano
triplex glass diffusers. Traditional
lighting.

Gestell aus galvanisch
beschichtetem Metall. Schirme
aus Triplex-Glas aus Murano.
Herkömmliche Leuchtmittel.

Estructura de metal galvanizado.
Difusores de cristal de Murano
triplex. Iluminación tradicional.

Structure en métal galvanisé.
Diffuseurs en verre triplex de
Murano. Éclairage traditionnel.

Каркас из оцинкованного
металла. Плафоны из
муранского стекла триплекс.
Традиционное освещение..

镀锌金属灯体结构。穆拉诺三层玻璃
灯罩。传统照明。

هيكل من المعدن المجلفن. ناشرات ضوء من زجاج
مورانو ثلاثي. إضاءة تقليدية.



G25 Rame dorato
Golden copper



Vetro triplex di Murano
Triplex Murano glass

TEE S1 20		CE	UL
Ø	20 cm / 7.90"		
H	27 cm / 10.60"		
STANDARD LIGHTING			
	1xE14x15 W MAX (NOT INCL.)*		
USA	1xE12x40 W MAX (NOT INCL.)*		
	* BULB MAX Ø 37 mm L 70 mm		

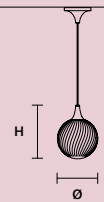

TEE S1 30		CE	UL
Ø	30 cm / 11.80"		
H	37 cm / 14.60"		
STANDARD LIGHTING			
	1xE27x20 W MAX (NOT INCL.)*		
USA	1xE26x60 W MAX (NOT INCL.)*		
	* BULB MAX Ø 62 mm L 185 mm		

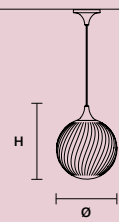

TEE PL1 20		CE	UL
Ø	20 cm / 7.90"		
H	49 cm / 19.30"		
STANDARD LIGHTING			
	1xE14x15 W MAX (NOT INCL.)*		
USA	1xE12x40 W MAX (NOT INCL.)*		
	* BULB MAX Ø 37 mm L 70 mm		

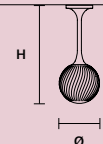

TEE PL1 30		CE	UL
Ø	30 cm / 11.80"		
H	64 cm / 25.20"		
STANDARD LIGHTING			
	1xE27x20 W MAX (NOT INCL.)*		
USA	1xE26x60 W MAX (NOT INCL.)*		
	* BULB MAX Ø 62 mm L 185 mm		

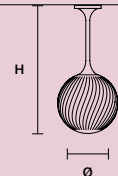

TEE PL5		CE	UL
Ø	85 cm / 33.50"		
H	68 cm / 26.80"		
STANDARD LIGHTING			
	5xE14x15 W MAX (NOT INCL.)*		
USA	5xE12x40 W MAX (NOT INCL.)*		
	* BULB MAX Ø 37 mm L 70 mm		

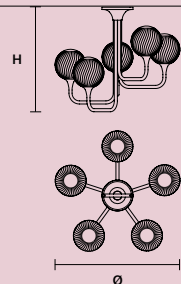

TEE PL6 95		CE	UL
Ø	94 cm / 37.00"		
H	66.5 cm / 26.20"		
STANDARD LIGHTING			
	6xE14x15 W MAX (NOT INCL.)*		
USA	6xE12x40 W MAX (NOT INCL.)*		
	* BULB MAX Ø 37 mm L 70 mm		

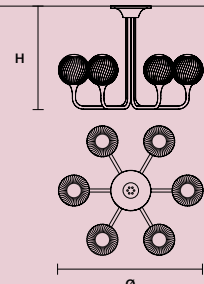

TEE PL8 RD 120		CE	UL
Ø	120 cm / 47.20"		
H	76.5 cm / 30.10"		
STANDARD LIGHTING			
	8xE14x15 W MAX (NOT INCL.)*		
USA	8xE12x40 W MAX (NOT INCL.)*		
	* BULB MAX Ø 37 mm L 70 mm		

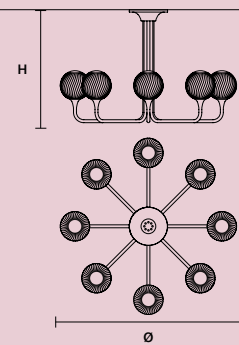

TEE PL8 RD 160		CE	UL
Ø	167 cm / 65.70"		
H	83.5 cm / 32.90"		
STANDARD LIGHTING			
	8xE27x20 W MAX (NOT INCL.)*		
USA	8xE26x60 W MAX (NOT INCL.)*		
	* BULB MAX Ø 62 mm L 185 mm		

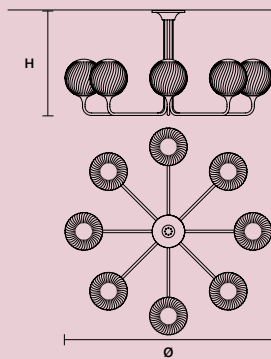

TEE PL 4+4 RD 100		CE	UL
Ø	100 cm / 39.40"		
H	100 cm / 39.40"		
STANDARD LIGHTING			
	8xE14x15 W MAX (NOT INCL.)*		
USA	8xE12x40 W MAX (NOT INCL.)*		
	* BULB MAX Ø 37 mm L 70 mm		

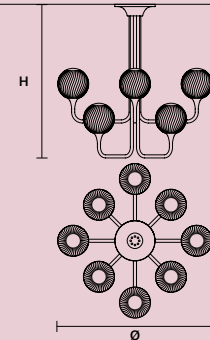

TEE PL 5+5 RD 120		CE	UL
Ø	120 cm / 47.20"		
H	83.5 cm / 32.90"		
STANDARD LIGHTING			
	10xE14x15 W MAX (NOT INCL.)*		
USA	10xE12x40 W MAX (NOT INCL.)*		
	* BULB MAX Ø 37 mm L 70 mm		

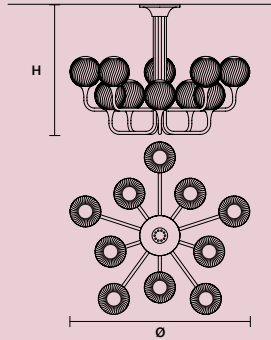

TEE PL8 OV 120		CE	UL
Ø	120 cm / 47.20"		
SP	80 cm / 31.50"		
H	63.5 cm / 25.00"		
STANDARD LIGHTING			
	8xE14x15 W MAX (NOT INCL.)*		
USA	8xE12x40 W MAX (NOT INCL.)*		
	* BULB MAX Ø 37 mm L 70 mm		

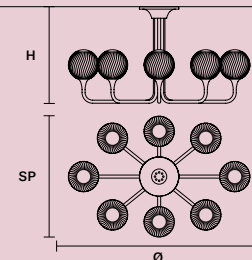

TEE PL8 OV 160		CE	UL
Ø	160 cm / 63.00"		
SP	107 cm / 42.10"		
H	63.5 cm / 25.00"		
STANDARD LIGHTING			
	8xE14x15 W MAX (NOT INCL.)*		
USA	8xE12x40 W MAX (NOT INCL.)*		
	* BULB MAX Ø 37 mm L 70 mm		

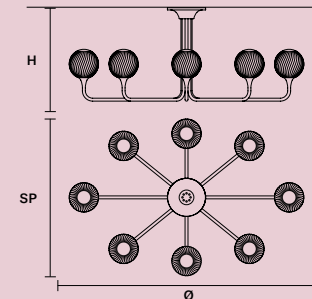

For the US market, refer to
the relevant price list.

TEE A1 20 

L 20 cm / 7.90"
 SP 26 cm / 10.20"
 H 41 cm / 16.10"

STANDARD LIGHTING

1×E14×15 W MAX (NOT INCL.)*

USA 1×E12×40 W MAX (NOT INCL.)*

* BULB MAX Ø 37 mm L 70 mm

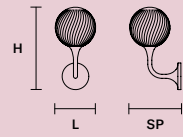

TEE TL1 20 

ø 20 cm / 7.90"
 H 48 cm / 18.90"

STANDARD LIGHTING

1×E14×15 W MAX (NOT INCL.)*

USA 1×E12×40 W MAX (NOT INCL.)*

* BULB MAX Ø 37 mm L 70 mm



TEE STL1 

ø 30 cm / 11.80"
 H 160 cm / 63.00"

STANDARD LIGHTING

1×E14×15 W MAX (NOT INCL.)*

USA 1×E12×40 W MAX (NOT INCL.)*

* BULB MAX Ø 62 mm L 185 mm

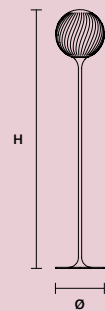

TEE STL3 

L 52 cm / 20.50"
 SP 45 cm / 17.70"
 H 170 cm / 66.90"

STANDARD LIGHTING

2×E14×15 W MAX (NOT INCL.)*

1 xE27 x 20 W MAX (NOT INCL.)**

USA 2×E12×40 W MAX (NOT INCL.)*

1×E26×60 W MAX (NOT INCL.)**

* BULB MAX Ø 37 mm L 70 mm

** BULB MAX Ø 62 mm L 185 mm

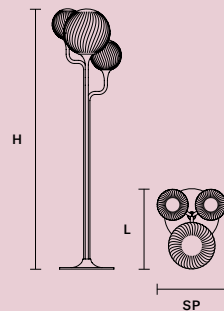

TEE C3 RD 40 

ø 44 cm / 17.30"
 H MAX 175 cm / 68.90"

STANDARD LIGHTING

3×E14×15 W MAX (NOT INCL.)*

USA 3×E12×40 W MAX (NOT INCL.)*

* BULB MAX Ø 37 mm L 70 mm

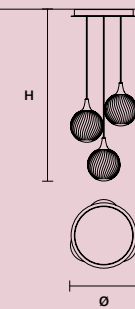

TEE C5 RD 60 

ø 62 cm / 24.40"
 H MAX 175 cm / 68.90"

STANDARD LIGHTING

5×E14×15 W MAX (NOT INCL.)*

USA 5×E12×40 W MAX (NOT INCL.)*

* BULB MAX Ø 37 mm L 70 mm

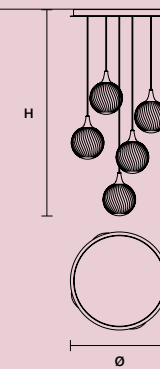

TEE C7 RD 80 

ø 80 cm / 31.50"
 H MAX 175 cm / 68.90"

STANDARD LIGHTING

7×E14×15 W MAX (NOT INCL.)*

USA 7×E12×40 W MAX (NOT INCL.)*

* BULB MAX Ø 37 mm L 70 mm

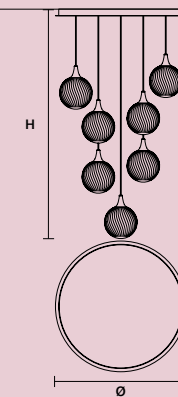

TEE C3 LN 75 

L 75 cm / 29.50"
 H MAX 175 cm / 68.90"

STANDARD LIGHTING

3×E14×15 W MAX (NOT INCL.)*

USA 3×E12×40 W MAX (NOT INCL.)*

* BULB MAX Ø 37 mm L 70 mm

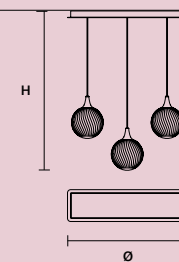

TEE C5 LN 125 

L 125 cm / 49.20"
 H MAX 175 cm / 68.90"

STANDARD LIGHTING

5×E14×15 W MAX (NOT INCL.)*

USA 5×E12×40 W MAX (NOT INCL.)*

* BULB MAX Ø 37 mm L 70 mm

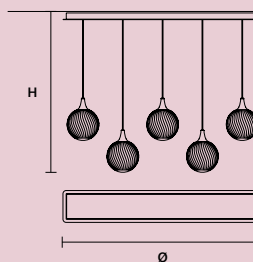

TEE C7 LN 175 

L 175 cm / 68.90"
 H MAX 175 cm / 68.90"

STANDARD LIGHTING

7×E14×15 W MAX (NOT INCL.)*

USA 7×E12×40 W MAX (NOT INCL.)*

* BULB MAX Ø 37 mm L 70 mm

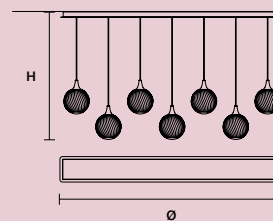

*  : ONLY FOR THE US MARKET.

Ebe

IT Ebe è ispirata all'eleganza mitologica delle statue del Canova. Metallo, marmo e una rete di maglia in filo di ottone intergiscono tra di loro creando geometrie luminose di una bellezza austera, senza tempo.

EN Ebe is inspired by the mythological elegance of Canova's statues. Metal, marble and a brass wire mesh are intertwined to create luminous geometries of timeless, austere beauty.

DESIGN BY
NICOLA GALLIZIA

APPLIQUE
TABLE LAMP
FLOOR LAMP

EBE A
EBE TL









Ebe

Struttura in metallo verniciato. Rete in maglia metallica in filo di ottone. Base in onice. Illuminazione a Led.

Painted metal structure. Brass wire mesh design. Onyx base. LED lighting.

Gestell aus lackiertem Metall. Metalldrahtgeflecht aus Messingdraht. Fuss aus Onyx. LED-Leuchtmittel.



Estructura de metal barnizado. Red de malla de alambre de latón. Base de ónix. Iluminación Led.

Structure en métal laqué. Maille métallique en fil de laiton. Base en onyx. Éclairage LED.

Каркас из окрашенного металла. Металлическая сетка из латунной проволоки. Основание из оникса. Светодиодное освещение.

涂色金属灯体结构。黄铜丝金属网格。玛瑙底座。Led照明。

هيكل معدني مطلي . شبكة معدنية من أسلاك النحاس الأصفر . قاعدة من العقيق . إضاءة ليد.

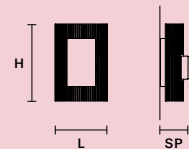

EBE A		  
L	27 cm / 10.60"	
SP	14 cm / 5.50"	
H	40 cm / 15.70"	
STANDARD LIGHTING		
	1×E14×10 W MAX (NOT INCL.)	
USA		
	1×E12×40 W MAX (NOT INCL.)	

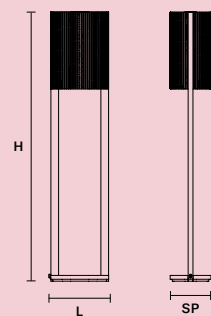

EBE STL		  
L	30 cm / 11.80"	
SP	21 cm / 8.25"	
H	140 cm / 55.10"	
INTEGRATED LED LIGHTING		
	35 W CRI>95	
	3000 K – 3770 NOMINAL LM	

DIMM OWN BUTTON



EBE TL		  
L	30 cm / 11.80"	
SP	21 cm / 8.25"	
H	40 cm / 15.70"	
INTEGRATED LED LIGHTING		
	11 W CRI>95	
	3000 K – 1200 NOMINAL LM	

DIMM OWN BUTTON

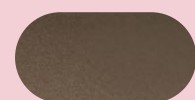
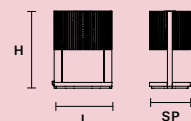

v87 Cioccolato Fondente
Foundant Chocolate



Brass wire mesh

 For the US market, refer to the relevant price list.

Posy

IT Equilibrio e semplicità sono le parole chiave di Posy. Sfera e stelo interagiscono tra di loro fino a trovare un equilibrio naturale che crea stupore per la naturale bellezza.

EN Balance and simplicity are the keywords of Posy. The sphere and stem interact with each other to achieve a natural balance that amazes for its natural beauty.

POSYVERT 3

DESIGN BY
SARA MORONI

SUSPENSION
APPLIQUE
TABLE LAMP
FLOOR LAMP















Posy

Struttura in metallo galvanizzato.
Diffusore in vetro triplex di Murano
bianco opalino.

Galvanic metal structure . Triplex
opal white Murano glass diffuser.

Galvanisierte Metallstruktur.
Opalweisser Triplex-Diffusor aus
Muranoglas.

Estructura de metal galvanizado.
Difusor de vidrio triplex de Murano
blanco opalino.

Structure en métal galvanisé.
Diffuseur en verre triplex de
Murano opale blanc.

Металлическая структура с
гальваническим покрытием.
Рассеиватель из триплексного
муранского стекла бело-
опалового цвета.

这种灯具的结构是电镀的金属，光扩
散是白色Murano三层玻璃做的。

هيكل من المعدن المجلفن.
ناشر ضوء من زجاج ثلاثي أبيض
مورانو أوبال.



G18 Ottone spazzolato
Brushed brass



Vetro triplex di Murano
Triplex Murano glass

POSY S1 12	
L	18 cm / 7.09"
SP	12 cm / 4.72"
H	14 cm / 5.51"
STANDARD LIGHTING	
1xG9x10 W MAX (NOT INCL.)*	
USA	1xG9x10 W MAX (NOT INCL.)*
* BULB MAX Ø 37 mm L 70 mm	

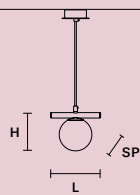

POSY S1 16	
L	22 cm / 8.66"
SP	16 cm / 6.30"
H	18 cm / 7.09"
STANDARD LIGHTING	
1xE14x10 W MAX (NOT INCL.)*	
USA	1xE12x10 W MAX (NOT INCL.)*
* BULB MAX Ø 37 mm L 110 mm	

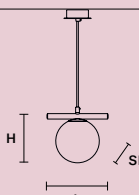

POSY S1 20	
L	26 cm / 10.24"
SP	20 cm / 7.87"
H	22 cm / 8.66"
STANDARD LIGHTING	
1xE14x10 W MAX (NOT INCL.)*	
USA	1xE12x10 W MAX (NOT INCL.)*
* BULB MAX Ø 37 mm L 150 mm	

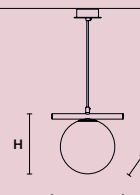

POSY A1 P	
L	22 cm / 8.66"
SP	22 cm / 8.66"
H	16 cm / 6.30"
STANDARD LIGHTING	
1xE14x10 W MAX (NOT INCL.)*	
USA	1xE12x10 W MAX (NOT INCL.)*
* BULB MAX Ø 37 mm L 110 mm	

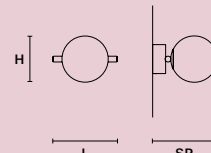

POSY A1 G	
L	26 cm / 10.24"
SP	26 cm / 10.24"
H	20 cm / 7.87"
STANDARD LIGHTING	
1xE14x10 W MAX (NOT INCL.)*	
USA	1xE12x10 W MAX (NOT INCL.)*
* BULB MAX Ø 37 mm L 110 mm	

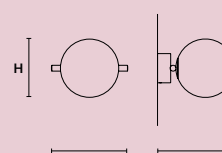

POSY TL	
L	26 cm / 10.24"
SP	20 cm / 7.87"
H	20 cm / 7.87"
STANDARD LIGHTING	
1xE14x10 W MAX (NOT INCL.)*	
USA	1xE12x7 W MAX (NOT INCL.)*
* BULB MAX Ø 37 mm L 110 mm	

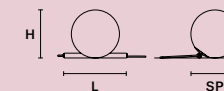

POSY STL	
L	39 cm / 15.35"
SP	32 cm / 12.60"
H	152 cm / 59.84"
STANDARD LIGHTING	
1xG9x10 W MAX (NOT INCL.)*	
2xE14x10 W MAX (NOT INCL.)**	
USA	1xG9x10 W MAX (NOT INCL.)*
2xE12x10 W MAX (NOT INCL.)**	
* BULB MAX Ø 37 mm L 70 mm	
** BULB MAX Ø 37 mm L 110 mm	

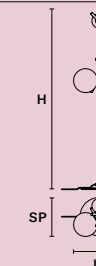

POSY S1 25	
L	31 cm / 12.20"
SP	25 cm / 9.84"
H	29 cm / 11.42"
STANDARD LIGHTING	
1xE27x20 W MAX (NOT INCL.)*	
USA	1xE26x60 W MAX (NOT INCL.)*
* BULB MAX Ø 62 mm L 185 mm	

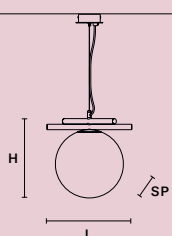

POSY BIL3	
L	100 cm / 39.37"
SP	33 cm / 12.99"
H	34 cm / 13.39"
STANDARD LIGHTING	
1xG9x10 W MAX (NOT INCL.)*	
2xE14x10 W MAX (NOT INCL.)**	
USA	1xG9x10 W MAX (NOT INCL.)*
2xE12x10 W MAX (NOT INCL.)**	
* BULB MAX Ø 37 mm L 70 mm	
** BULB MAX Ø 37 mm L 110 mm	

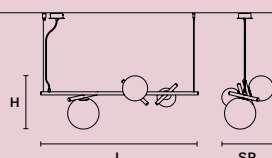

POSY BIL4	
L	140 cm / 55.12"
SP	38 cm / 14.96"
H	29 cm / 11.42"
STANDARD LIGHTING	
1xG9x10 W MAX (NOT INCL.)*	
3xE14x10 W MAX (NOT INCL.)**	
USA	1xG9x10 W MAX (NOT INCL.)*
3xE12x10 W MAX (NOT INCL.)**	
* BULB MAX Ø 37 mm L 70 mm	
** BULB MAX Ø 37 mm L 110 mm	

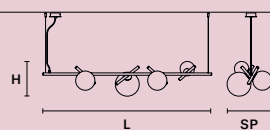

POSY S3	
ø	40 cm / 15.75"
H MAX	160 cm / 62.99"
STANDARD LIGHTING	
1xG9x10 W MAX (NOT INCL.)*	
2xE14x10 W MAX (NOT INCL.)**	
USA	1xG9x10 W MAX (NOT INCL.)*
2xE12x10 W MAX (NOT INCL.)**	
* BULB MAX Ø 37 mm L 70 mm	
** BULB MAX Ø 37 mm L 110 mm	

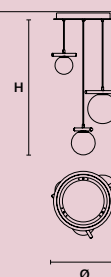

POSY S5	
ø	60 cm / 23.62"
H MAX	160 cm / 62.99"
STANDARD LIGHTING	
2xG9x10 W MAX (NOT INCL.)*	
3xE14x10 W MAX (NOT INCL.)**	
USA	2xG9x10 W MAX (NOT INCL.)*
3xE12x10 W MAX (NOT INCL.)**	
* BULB MAX Ø 37 mm L 70 mm	
** BULB MAX Ø 37 mm L 110 mm	



POSY C5 RD 40	
ø	40 cm / 15.75"
H MAX	160 cm / 62.99"
STANDARD LIGHTING	
5xG9x10 W MAX (NOT INCL.)*	
USA	5xG9x10 W MAX (NOT INCL.)*
* BULB MAX Ø 37 mm L 70 mm	



POSY C7 RD 60	
ø	60 cm / 23.62"
H MAX	160 cm / 62.99"
STANDARD LIGHTING	
7xG9x10 W MAX (NOT INCL.)*	
USA	7xG9x10 W MAX (NOT INCL.)*
* BULB MAX Ø 37 mm L 70 mm	

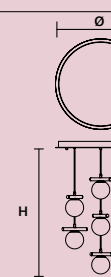

POSY BIL6	
L	180 cm / 70.87"
SP	42 cm / 16.53"
H	31 cm / 12.20"
STANDARD LIGHTING	
2xG9x10 W MAX (NOT INCL.)*	
4xE14x10 W MAX (NOT INCL.)**	
USA	2xG9x10 W MAX (NOT INCL.)*
4xE12x10 W MAX (NOT INCL.)**	
* BULB MAX Ø 37 mm L 70 mm	
** BULB MAX Ø 37 mm L 110 mm	

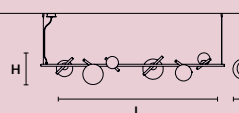

POSY VERT 2	
L	42 cm / 16.54"
SP	20 cm / 7.87"
H	102 cm / 40.16"
STANDARD LIGHTING	
2xE14x10 W MAX (NOT INCL.)*	
USA	2xE12x10 W MAX (NOT INCL.)*
* BULB MAX Ø 37 mm L 70 mm	

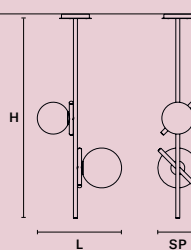

POSY VERT 3	
L	39 cm / 15.35"
SP	32 cm / 12.60"
H	142 cm / 55.91"
STANDARD LIGHTING	
1xG9x10 W MAX (NOT INCL.)*	
2xE14x10 W MAX (NOT INCL.)**	
USA	1xG9x10 W MAX (NOT INCL.)*
2xE12x10 W MAX (NOT INCL.)**	
* BULB MAX Ø 37 mm L 70 mm	
** BULB MAX Ø 37 mm L 110 mm	

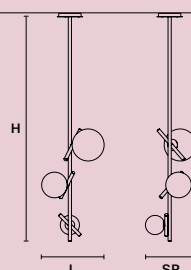

POSY C10 RD 80	
ø	80 cm / 31.49"
H MAX	160 cm / 62.99"
STANDARD LIGHTING	
10xG9x10 W MAX (NOT INCL.)*	
USA	10xG9x10 W MAX (NOT INCL.)*
* BULB MAX Ø 37 mm L 70 mm	

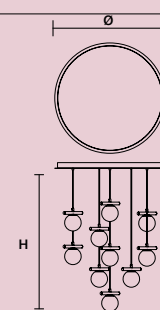

POSY C5 LN 75	
L	75 cm / 29.52"
SP	20 cm / 7.87"
H MAX	160 cm / 62.99"
STANDARD LIGHTING	
5xG9x10 W MAX (NOT INCL.)*	
USA	5xG9x10 W MAX (NOT INCL.)*
* BULB MAX Ø 37 mm L 70 mm	

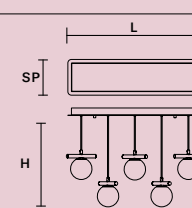

POSY C7 LN 125	
L	125 cm / 49.21"
SP	20 cm / 7.87"
H MAX	160 cm / 62.99"
STANDARD LIGHTING	
7xG9x10 W MAX (NOT INCL.)*	
USA	7xG9x10 W MAX (NOT INCL.)*
* BULB MAX Ø 37 mm L 70 mm	

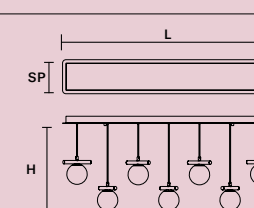

POSY C10 LN 175	
L	175 cm / 68.90"
SP	20 cm / 7.87"
H MAX	160 cm / 62.99"
STANDARD LIGHTING	
10xG9x10 W MAX (NOT INCL.)*	
USA	10xG9x10 W MAX (NOT INCL.)*
* BULB MAX Ø 37 mm L 70 mm	

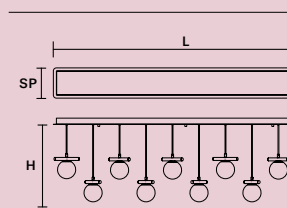

For the US market, refer to
the relevant price list.

Iglù

IT Iglù è un'intuizione che nasce osservando la perfezione dell'elemento sfera, che diventa una forma perfetta, riconoscibile ed unica grazie ad una rete che non trattiene la luce ma crea un disegno di luci e ombre, trasformando il metallo in un gioiello luminoso.

EN Iglù is an intuition born from observing the perfection of the sphere, transformed into a perfect, recognisable and unique shape by mesh that, rather than obstruct the light, instead creates a pattern of light and shadow, transforming the metal into a luminous jewel.

DESIGN BY
ORIANO FAVARETTO

SUSPENSION
CEILING
APPLIQUE
TABLE LAMP
FLOOR LAMP

IGLÙ S6+1







IGLÙ PL13
IGLÙ PL18
IGLÙ PL25







Iglù

Struttura in metallo verniciato con patina spazzolata. Illuminazione a LED.

Metal structure painted with brushed patina. LED lighting.

Metallstruktur mit gebürsteter Patina. LED-Beleuchtung.

Estructura de metal pintado con pátina cepillada. Iluminación led.

Structure en métal laqué avec patine brossé. Eclairage en LED.

Окрашенная металлическая структура с матовой патиной. Светодиодное освещение.

这种灯具的结构是涂漆的金属。LED照明。

هيكل معدني مطلي بطبقة مصقولة. إضاءة ليد.

IGLÙ S1 25

ø 25,5 cm / 10.04"
H 25,5 cm / 10.04"

INTEGRATED LED LIGHTING
15,5 W CRI>90
3000 K – 2100 NOMINAL LM

DIMM NO



IGLÙ S2

L 58 cm / 22.83"
H 18 cm / 7.09"
SP 18 cm / 7.09"

INTEGRATED LED LIGHTING
19,8 W CRI>90
3000 K – 2600 NOMINAL LM

DIMM 1-10V + PUSH

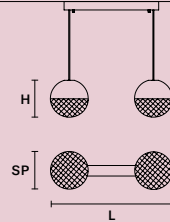

IGLÙ S6+1

ø 96 cm / 37.80"
H 52 cm / 20.47"

INTEGRATED LED LIGHTING
26,6 W CRI>90
3000 K – 3626 NOMINAL LM

DIMM NO

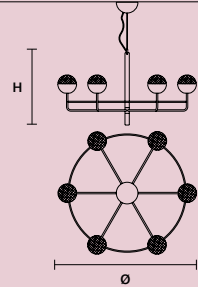

IGLÙ TL1

L 24 cm / 9.45"
SP 28 cm / 11.02"
H 55 cm / 21.65"

INTEGRATED LED LIGHTING
UP 3,7 W CRI>90
3000 K – 462 NOMINAL LM
DOWN 11,4 W CRI>90
3000 K – 1450 NOMINAL LM
DIMM OWN BUTTON

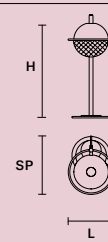

IGLÙ STL1

L 24 cm / 9.45"
SP 28 cm / 11.02"
H 162 cm / 63.78"

INTEGRATED LED LIGHTING
UP 3,7 W CRI>90
3000 K – 462 NOMINAL LM
DOWN 11,4 W CRI>90
3000 K – 1450 NOMINAL LM
DIMM OWN BUTTON

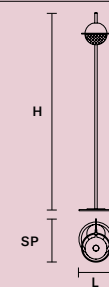

IGLÙ S7

ø 60 cm / 23.62"
H MAX 150 cm / 62.99"

INTEGRATED LED LIGHTING
52,3 W CRI>90
3000 K – 6700 NOMINAL LM

DIMM 1-10V + PUSH

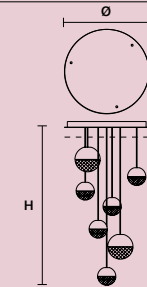

IGLÙ C5 RD 40

ø 40cm/ 15.74"
H MAX 150 cm / 59.05"

INTEGRATED LED LIGHTING
27W CRI>90
3000K - 3440 NOMINAL LM

DIMM PUSH + 1-10V



IGLÙ S12+1

ø 96 cm / 37.80"
H 68 cm / 26.77"

INTEGRATED LED LIGHTING
49,4 W CRI>90
3000 K – 6734 NOMINAL LM

DIMM TRIAC

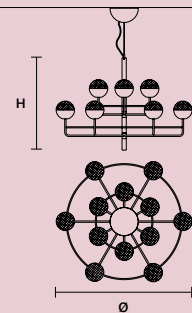

IGLÙ S18+1

ø 136 cm / 53.54"
H 82 cm / 32.28"

INTEGRATED LED LIGHTING
73,5 W CRI>90
3000 K – 10258 NOMINAL LM

DIMM TRIAC

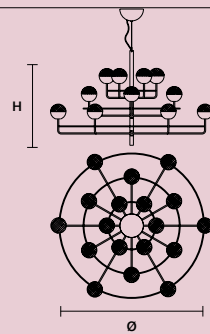

IGLÙ PL 13

ø 13 cm / 5.12"
H 13 cm / 5.12"

INTEGRATED LED LIGHTING
5,4 W CRI>90
3000 K – 688 NOMINAL LM

DIMM NO

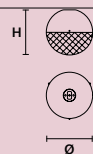

IGLÙ C7 RD 60

ø 60cm/ 23.62"
H MAX 150 cm / 59.05"

INTEGRATED LED LIGHTING
37,8W CRI>90
3000K - 4816 NOMINAL LM

DIMM PUSH + 1-10V

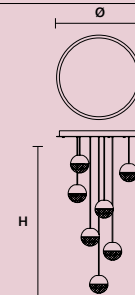

IGLÙ C10 RD 80

ø 80cm/ 31.49"
H MAX 150 cm / 59.05"

INTEGRATED LED LIGHTING
54W CRI>90
3000K - 6880 NOMINAL LM

DIMM PUSH + 1-10V + DALI

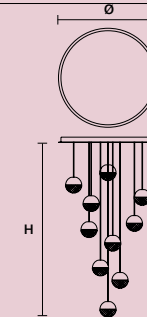

IGLÙ C5 LN 75

L 75 cm / 29.52"
SP 20 cm / 7.87"
H MAX 150 cm / 59.05"

INTEGRATED LED LIGHTING
27W CRI>90
3000K - 3440 NOMINAL LM

DIMM PUSH + 1-10V

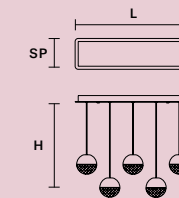

IGLÙ C7 LN 125

L 125 cm / 49.21"
SP 20 cm / 7.87"
H MAX 150 cm / 59.05"

INTEGRATED LED LIGHTING
37,8W CRI>90
3000K - 4816 NOMINAL LM

DIMM PUSH + 1-10V

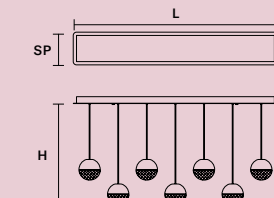

IGLÙ PL 18

ø 18 cm / 7.09"
H 18 cm / 7.09"

INTEGRATED LED LIGHTING
11,4 W CRI>90
3000 K – 1450 NOMINAL LM

DIMM NO



IGLÙ PL 25

ø 25,5 cm / 10.04"
H 25,5 cm / 10.04"

INTEGRATED LED LIGHTING
15,5 W CRI>90
3000 K – 2100 NOMINAL LM

DIMM NO

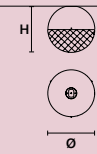

IGLÙ A1

L 24 cm / 9.45"
SP 28 cm / 11.02"
H 18 cm / 7.09"

INTEGRATED LED LIGHTING
UP 2,6 W CRI>90
3000 K – 346 NOMINAL LM
DOWN 8,4 W CRI>90
3000 K – 1150 NOMINAL LM
DIMM TRIAC

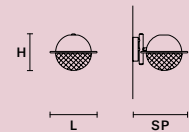

IGLÙ C10 LN 175

L 175 cm / 68.89"
SP 20 cm / 7.87"
H MAX 150 cm / 59.05"

INTEGRATED LED LIGHTING
54W CRI>90
3000K - 6880 NOMINAL LM

DIMM PUSH + 1-10V + DALI

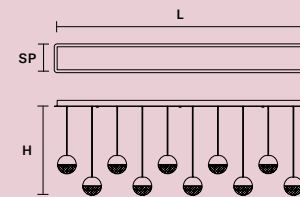

For the US market, refer to the relevant price list.

Horo

IT Horo trae ispirazione dalla forma del cerchio nelle sue infinite espressioni come il sole, disco di luce e simbolo universalmente noto e antico quanto il mondo. Horo è una collezione minimal, semplice, una 'forma grafica' che assume un mood vintage grazie alle particolari finiture di metallo e vetro.

EN Horo is inspired by the shape of a circle in all its infinite expressions such as the sun, a disc of light and a universally recognised symbol, as old as the world itself. Horo is a simple, minimal collection, a "graphic form" given a vintage mood by the special metal and glass finishes.



"As Awarded by The Chicago Athenaeum: Museum of Architecture and Design"

DESIGN BY
PIERRE GONALONS

SUSPENSION
APPLIQUE
TABLE LAMP
FLOOR LAMP







HORO A



HORO S1



HORO S3





HORO TL





Horo

Struttura in metallo con diffusore in vetro prismatico o decorazione spectrum. Illuminazione a LED.

Metal frame with prism or spectrum finishing glass diffuser. LED lighting.

Gestell aus Metall mit Diffusor aus Prismen oder Spectrum Glass. LED-Beleuchtung.

Estructura de metal con difusor de vidrio prismatico o decoración espectral. Iluminación LED.

Structure en métal avec diffuseur en verre prismatique ou décoration spectrum. Éclairage LED.

Металлический каркас с рассеивателем из призматического стекла или цветного стекла Spectrum. Светодиодное освещение.

这种灯具有金属结构，然而它有一个棱镜玻璃的光扩散。LED照明。

هيكل معدني مع ناشر ضوء زجاجي موشوري أو زخرفة طيفية. إضاءة LED.



G18 Ottone spazzolato
Brushed Brass

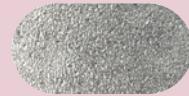

TR Vetro trasparente
Transparent glass



FM Vetro fumè
Smoky glass

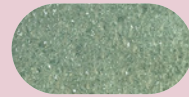

VD Vetro verde
Green glass



AZ Vetro azzurro
Light Blue glass

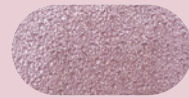

RS Vetro rosa
Pink glass



SA Spectrum ambra
Amber spectrum

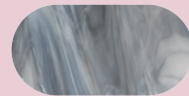

SG Spectrum grigio
Grey spectrum

HORO S1	
L	30 cm / 11.81"
SP	8 cm / 3.14"
H	34 cm / 13.38"
INTEGRATED LED LIGHTING	
LED	14,4 W CRI>95 3000 K – 1854 NOMINAL LM
DIMM	NO



HORO S3	
INTEGRATED LED LIGHTING	
LED	43,2 W CRI>95 3000 K – 5562 NOMINAL LM
DIMM	0-10V

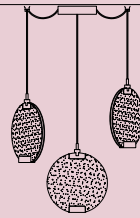

HORO S5	
INTEGRATED LED LIGHTING	
LED	72 W CRI>95 3000 K – 9270 NOMINAL LM
DIMM	PUSH



HORO A	
L	30 cm / 11.81"
SP	12 cm / 4.72"
H	30 cm / 11.81"
INTEGRATED LED LIGHTING	
LED	14,4 W CRI>95 3000 K – 1854 NOMINAL LM
DIMM	NO

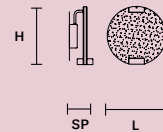

HORO TL	
L	30 cm / 11.81"
SP	20 cm / 7.87"
H	60 cm / 23.62"
INTEGRATED LED LIGHTING	
LED	14,4 W CRI>95 3000 K – 1854 NOMINAL LM
DIMM	OWN BUTTON

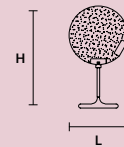

HORO STL	
L	30 cm / 7.87"
SP	25 cm / 9.84"
H	150 cm / 59.05"
INTEGRATED LED LIGHTING	
LED	14,4 W CRI>95 3000 K – 1854 NOMINAL LM
DIMM	OWN BUTTON

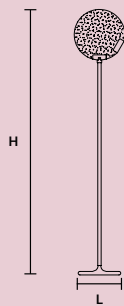

HORO C3 LN 125	
L	125 cm / 49.21"
SP	20 cm / 7.87"
H MAX	155 cm / 61.02"
INTEGRATED LED LIGHTING	
LED	43,2 W CRI>95 3000 K – 5562 NOMINAL LM
DIMM	0-10V

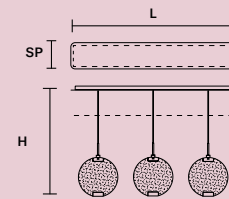

HORO C5 LN 175	
L	175 cm / 68.89"
SP	20 cm / 7.87"
H MAX	155 cm / 61.02"
INTEGRATED LED LIGHTING	
LED	72 W CRI>95 3000 K – 9270 NOMINAL LM
DIMM	0-10V

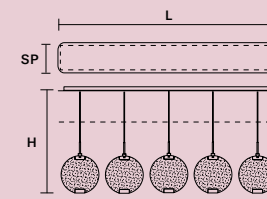

HORO C3 RD 60	
ø	60 cm / 23.62"
H MAX	155 cm / 61.02"
INTEGRATED LED LIGHTING	
LED	43,2 W CRI>95 3000 K – 5562 NOMINAL LM
DIMM	0-10V

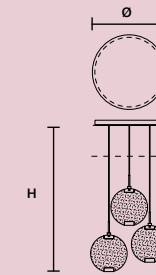

HORO C5 RD 80	
ø	80 cm / 31.49"
H MAX	155 cm / 61.02"
INTEGRATED LED LIGHTING	
LED	72 W CRI>95 3000 K – 9270 NOMINAL LM
DIMM	0-10V

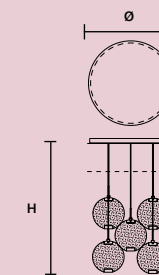

For the US market, refer to the relevant price list.

Vegas

IT Vegas è liberamente ispirata all'architettura della città che non dorme mai, Las Vegas. Le iconiche luci Art Decò dallo stile classico e geometrico sono reinterpretate in chiave contemporanea, accostando vetro e metallo utilizzando le più moderne tecniche di lavorazione.

EN Vegas is loosely inspired by the architecture of Las Vegas, the city that never sleeps. With their classic geometric style, the iconic Art Deco lights are reinterpreted in a contemporary key, combining glass and metal using the most modern manufacturing techniques.

VEGAS VRT 70
VEGAS VRT 140
VEGAS VRT 180

DESIGN BY
MARC SADLER

SUSPENSION
APPLIQUE
TABLE LAMP
FLOOR LAMP





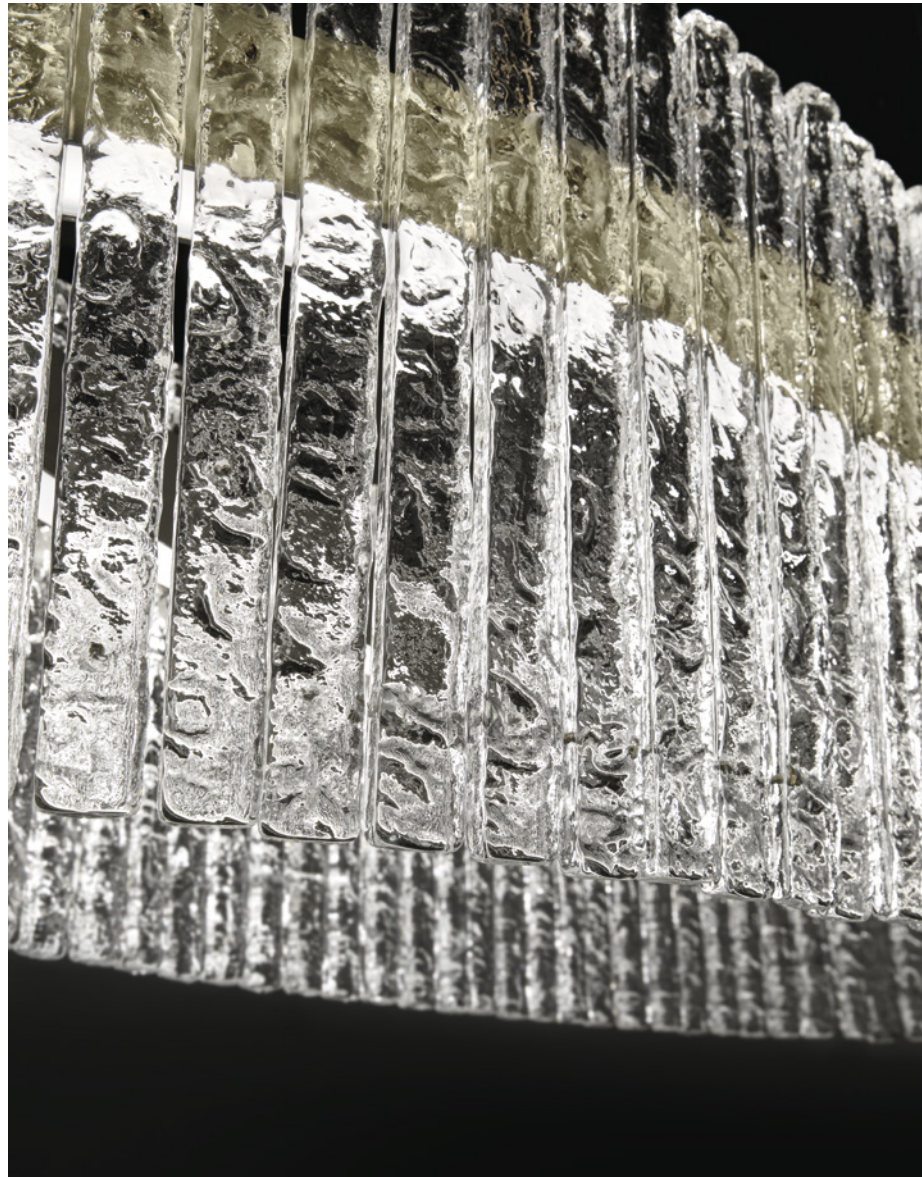





VEGAS A PVRT



VEGAS A G VRT



VEGAS S OV 120





VEGAS VRT 70
VEGAS VRT 140
VEGAS VRT 180



VEGAS TL G

Vegas

Struttura in metallo con diffusore in listelli di vetro effetto roccia Illuminazione a LED.

Metal frame with diffuser in strips of rock looking glass. LED lighting.

Gestell aus Metall mit Diffusor aus Glasleisten, Gestein aussehend. LED-Beleuchtung.

Estructura de metal con difusor en listones de cristal efecto roca. Iluminación LED.

Structure en métal peint avec diffuseur en bandes de verre effet roche. Éclairage à LED.

Металлический каркас с рассеивателем из стекла с эффектом горного хрусталя. Светодиодное освещение.

这种灯具具有金属结构，而且在灯具外面有岩石类似的玻璃条们。LED照明。

هيكل معدني مع ناشر ضوء في شرائح زجاجية ذات تأثير صخري. إضاءة ليد.



F04 Foglia champagne Champagne leaf

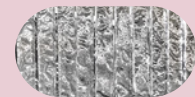

Hand made glass

VEGAS S RD12

∅ 12 cm / 4.72"
H 28 cm / 11.02"

INTEGRATED LED LIGHTING

5,4 W CRI>90
3000K - 688 NOMINAL LM
DIMM NO



VEGAS S RD40

∅ 40 cm / 15.74"
H 40 cm / 15.74"

INTEGRATED LED LIGHTING

30 W CRI>95
3000 K - 3862 NOMINAL LM
DIMM 0-10V



VEGAS S RD60

∅ 60 cm / 23.62"
H 40 cm / 15.74"

INTEGRATED LED LIGHTING

56,4 W CRI>95
3000 K - 7261 NOMINAL LM
DIMM 0-10V

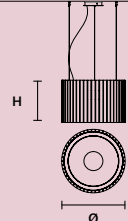

VEGAS S VRT90

∅ 27 cm / 10.62"
H 94 cm / 37.00"

INTEGRATED LED LIGHTING

41 W CRI>95
3000 K - 5253 NOMINAL LM
DIMM 0-10V

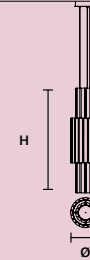

VEGAS S VRT140

∅ 27 cm / 10.62"
H 135 cm / 53.14"

INTEGRATED LED LIGHTING

56 W CRI>95
3000 K - 7261 NOMINAL LM
DIMM 0-10V



VEGAS S VRT180

∅ 27 cm / 10.62"
H 175 cm / 68.89"

INTEGRATED LED LIGHTING

72 W CRI>95
3000 K - 9270 NOMINAL LM
DIMM 0-10V



VEGAS BIL 90

L 94 cm / 37.00"
SP 27 cm / 10.62"
H 27 cm / 10.62"

INTEGRATED LED LIGHTING

41 W CRI>95
3000 K - 5253 NOMINAL LM
DIMM 0-10V

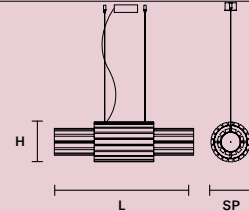

VEGAS S RD40 DB

∅ 40 cm / 15.74"
H 50 cm / 19.68"

INTEGRATED LED LIGHTING

33 W CRI>95
3000 K - 4248 NOMINAL LM
DIMM 0-10V



VEGAS S RD 60DB

∅ 60 cm / 23.62"
H 50 cm / 19.68"

INTEGRATED LED LIGHTING

55 W CRI>95
3000 K - 6592 NOMINAL LM
DIMM 0-10V

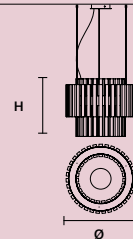

VEGAS S OV85

L 85 cm / 33.46"
SP 34 cm / 13.38"
H 40 cm / 15.74"

INTEGRATED LED LIGHTING

58,8 W CRI>95
3000 K - 7570 NOMINAL LM
DIMM 0-10V

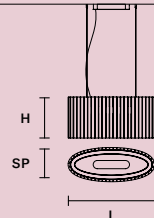

VEGAS BIL 140

L 135 cm / 53.14"
SP 27 cm / 10.62"
H 27 cm / 10.62"

INTEGRATED LED LIGHTING

56 W CRI>95
3000 K - 7261 NOMINAL LM
DIMM 0-10V

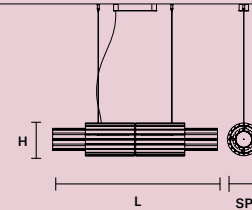

VEGAS BIL 180

L 175 cm / 68.89"
SP 27 cm / 10.62"
H 27 cm / 10.62"

INTEGRATED LED LIGHTING

72 W CRI>95
3000 K - 9270 NOMINAL LM
DIMM 0-10V

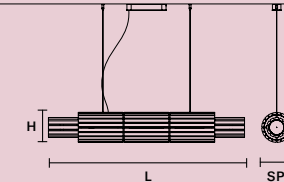

VEGAS A P VRT

L 28 cm / 11.02"
SP 10 cm / 3.93"
H 38 cm / 14.96"

INTEGRATED LED LIGHTING

7 W CRI>95
3000 K - 927 NOMINAL LM
DIMM NO

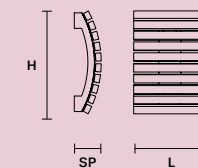

VEGAS A G VRT

L 28 cm / 11.02"
SP 10 cm / 3.93"
H 79 cm / 31.10"

INTEGRATED LED LIGHTING

14 W CRI>95
3000 K - 1854 NOMINAL LM
DIMM NO

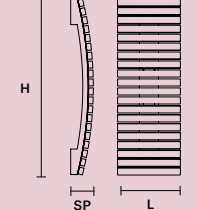

VEGAS S OV120

L 120 cm / 47.24"
SP 48 cm / 18.89"
H 40 cm / 15.74"

INTEGRATED LED LIGHTING

87,6 W CRI>95
3000 K - 8806 NOMINAL LM
DIMM 0-10V

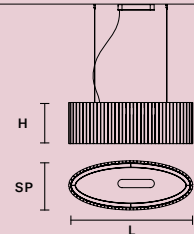

VEGAS S OV160

L 160 cm / 62.99"
SP 65 cm / 25.59"
H 40 cm / 15.74"

INTEGRATED LED LIGHTING

119 W CRI>95
3000 K - 15372 NOMINAL LM
DIMM 0-10V

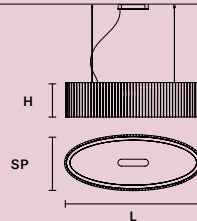

VEGAS S VRT70

∅ 27 cm / 10.62"
H 67 cm / 26.37"

INTEGRATED LED LIGHTING

21 W CRI>95
3000 K - 2781 NOMINAL LM
DIMM 0-10V

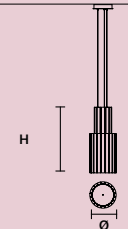

VEGAS A P

L 38 cm / 14.96"
SP 10 cm / 3.93"
H 28 cm / 11.02"

INTEGRATED LED LIGHTING

7 W CRI>95
3000 K - 927 NOMINAL LM
DIMM NO

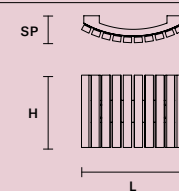

VEGAS A G

L 79 cm / 31.10"
SP 10 cm / 3.93"
H 28 cm / 11.02"

INTEGRATED LED LIGHTING

14 W CRI>95
3000 K - 1854 NOMINAL LM
DIMM NO

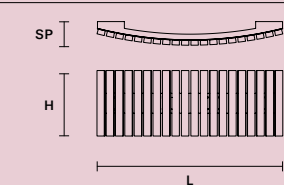

VEGAS TL G

L 30 cm / 11.81"
SP 18 cm / 7.08"
H 45 cm / 17.71"

INTEGRATED LED LIGHTING

10,8 W CRI>95
3000 K - 1390 NOMINAL LM
DIMM OWN BUTTON

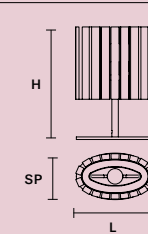

VEGAS STL

L 57 cm / 22.40"
SP 30 cm / 11.80"
H 160 cm / 63.00"

INTEGRATED LED LIGHTING

45,6 W CRI>95
3000 K - 4970 NOMINAL LM
DIMM OWN BUTTON

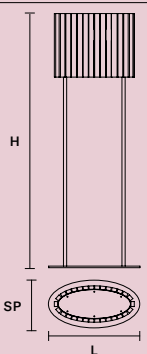

For the US market, refer to the relevant price list.

VEGAS C3 LN 75 

L	75 cm / 29.52"
SP	20 cm / 7.87"
H MAX	150 cm / 59.05"
INTEGRATED LED LIGHTING	
16,2 W CRI>90	
3000 K - 2064 NOMINAL LM	
DIMM	1-10V + PUSH

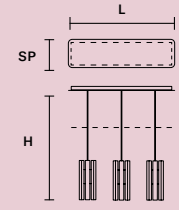

VEGAS C5 LN 125 

L	125 cm / 49.21"
SP	20 cm / 7.87"
H MAX	150 cm / 59.05"
INTEGRATED LED LIGHTING	
27 W CRI>90	
3000K - 3440 Nominal lm	
DIMM	1-10V + PUSH

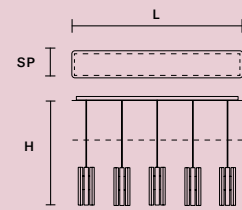

VEGAS C7 LN 175 

L	175 cm / 68.89"
SP	20 cm / 7.87"
H MAX	150 cm / 59.05"
INTEGRATED LED LIGHTING	
37,8 W CRI>90	
3000K - 4816 Nominal lm	
DIMM	1-10V + DALI + PUSH

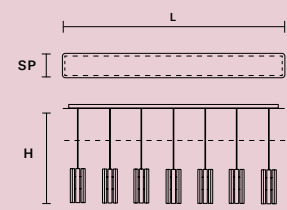

VEGAS C3 RD 40 

ø	40 cm / 15.74"
H MAX	150 cm / 59.05"
INTEGRATED LED LIGHTING	
16,2 W CRI>90	
3000K - 2064 Nominal lm	
DIMM	1-10V + PUSH

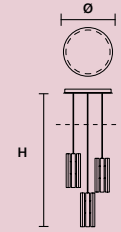

VEGAS C5 RD 60 

ø	60 cm / 23.62"
H MAX	150 cm / 59.05"
INTEGRATED LED LIGHTING	
27 W CRI>90	
3000K - 3440 Nominal lm	
DIMM	1-10V + PUSH

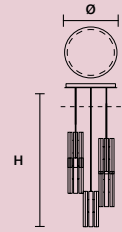

VEGAS C7 RD 80 

ø	80 cm / 31.49"
H MAX	150 cm / 59.05"
INTEGRATED LED LIGHTING	
37,8 W CRI>90	
3000K - 4816 Nominal lm	
DIMM	1-10V + DALI + PUSH

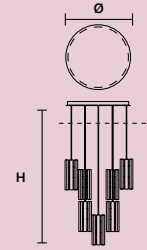

Honicé

HONICÉ S80

IT Honicé si ispira alla bellezza e maestosità di una delle pietre più antiche del mondo: l'onice. Secondo la leggenda l'onice sarebbe stata creata quando Cupido tagliò le unghie a Venere. Poichè le parti di una creatura divina non sono mortali, le divinità le trasformarono in una gemma, l'Onice. C'è della magia in lei, una pelle sottile, trasparente pur se di pietra. Honicé rende luminosa e leggera la solidità del marmo.

EN Honicé is inspired by the beauty and majesty of onyx, one of the oldest stones in the world. Legend has it that onyx was created when Cupid cut Venus' nails. Since the parts of a divine being cannot be mortal, the gods transformed them into a gemstone, onyx. It has something magical about it, a thin skin of stone, but transparent. Honicé brings brightness and luminosity to the solidity of marble.

DESIGN BY
ORIANO FAVARETTO

SUSPENSION
APPLIQUE
TABLE LAMP
FLOOR LAMP





HONICÉ S100



HONICÉ A65



HONICÉ A37





Honicé

Struttura in metallo con diffusore in onice naturale. Illuminazione a LED.

Metal frame with natural onyx diffuser. LED lighting.

Gestell aus Metall mit Diffusor aus natürlichem Onyx. LED-Beleuchtung.

Estructura de metal con difusor en ónix natural. Iluminación LED.

Structure en métal avec diffuseur en onyx naturel. Éclairage à LED.

Металлический каркас с рассеивателем из природного оникса. Светодиодное освещение.

这种灯具有金属结构，然而光扩散是缟玛瑙。LED照明。

هيكل معدني مع ناشر من الأونيكس الطبيعي. إضاءة ليد.



v99 Oro opaco verniciato
Painted matt gold



g01 Brunito*
Burnished

*NOT AVAILABLE FOR HONICÉ S80 AND HONICÉ S50



Onice
Onyx

HONICÉ S200	
L	200 cm / 78.74"
SP	8 cm / 3.14"
H	33 cm / 12.99"
INTEGRATED LED LIGHTING	
UP	21,1 W CRI>95 3000 K – 2781 NOMINAL LM
DOWN	44,46 W CRI>95 3000 K – 5871 NOMINAL LM
DIMM	0-10V

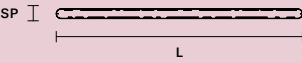

HONICÉ S150	
L	150 cm / 59.05"
SP	8 cm / 3.14"
H	33 cm / 12.99"
INTEGRATED LED LIGHTING	
UP	17 W CRI>95 3000 K – 1854 NOMINAL LM
DOWN	33,5 W CRI>95 3000 K – 4326 NOMINAL LM
DIMM	0-10V

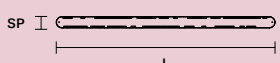

HONICÉ S100	
L	100 cm / 39.37"
SP	8 cm / 3.14"
H	33 cm / 12.99"
INTEGRATED LED LIGHTING	
UP	9,36 W CRI>95 3000 K – 1236 NOMINAL LM
DOWN	21,1 W CRI>95 3000 K – 2781 NOMINAL LM
DIMM	0-10V

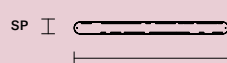

HONICÉ STL	
L	38 cm / 15.00"
SP	16 cm / 6.30"
H	160 cm / 63.00"
INTEGRATED LED LIGHTING	
UP	6 W CRI>95 3000 K – 860 NOMINAL LM
DOWN	6 W CRI>95 3000 K – 860 NOMINAL LM
DIMM	OWN BUTTON

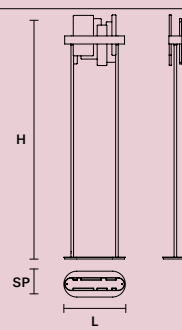

HONICÉ S70	
L	70 cm / 27.55"
SP	8 cm / 3.14"
H	33 cm / 12.99"
INTEGRATED LED LIGHTING	
UP	7 W CRI>95 3000 K – 927 NOMINAL LM
DOWN	15 W CRI>95 3000 K – 2008 NOMINAL LM
DIMM	0-10V

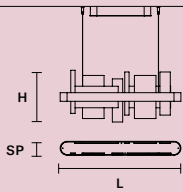

HONICÉ S80	
L	80 cm / 31.49"
SP	80 cm / 31.49"
H	33 cm / 12.99"
INTEGRATED LED LIGHTING	
UP	28,1 W CRI>95 3000 K – 4326 NOMINAL LM
DOWN	60,85 W CRI>95 3000 K – 7416 NOMINAL LM
DIMM	0-10V

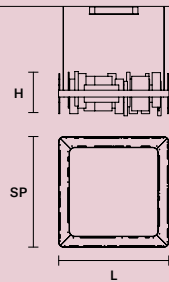

HONICÉ S50	
L	50 cm / 19.68"
SP	50 cm / 19.68"
H	33 cm / 12.99"
INTEGRATED LED LIGHTING	
UP	15,21 W CRI>95 3000 K – 2008 NOMINAL LM
DOWN	32,76 W CRI>95 3000 K – 4326 NOMINAL LM
DIMM	0-10V

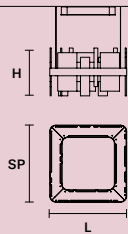

HONICÉ A65	
L	65 cm / 25.59"
SP	10 cm / 3.93"
H	33 cm / 12.99"
INTEGRATED LED LIGHTING	
UP	5,8 W CRI>95 3000 K – 849 NOMINAL LM
DOWN	5,8 W CRI>95 3000 K – 849 NOMINAL LM
DIMM	1-10V + PUSH

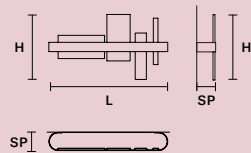

HONICÉ A37	
L	37 cm / 14.56"
SP	10 cm / 3.93"
H	33 cm / 12.99"
INTEGRATED LED LIGHTING	
UP	3,51 W CRI>95 3000 K – 463 NOMINAL LM
DOWN	3,51 W CRI>95 3000 K – 463 NOMINAL LM
DIMM	1-10V + PUSH

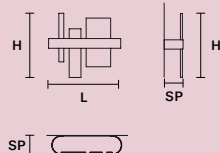

HONICÉ TL	
L	38 cm / 15.00"
SP	16 cm / 6.30"
H	48 cm / 18.90"
INTEGRATED LED LIGHTING	
UP	6 W CRI>95 3000 K – 860 NOMINAL LM
DOWN	6 W CRI>95 3000 K – 860 NOMINAL LM
DIMM	OWN BUTTON

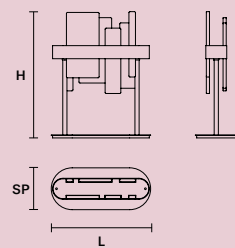

For the US market, refer to the relevant price list.

Nappe

IT La collezione Nappe è espressione del legame dell'azienda con il territorio. Ispirata alle nappine, ornamento tipico dei salotti veneziani del passato, utilizzate per chiudere le tende. Dalla scomposizione e semplificazione dell'oggetto sono state stilizzate dieci diverse forme di nappa.

EN The Nappe collection is an expression of the company's close ties to the local area. It is inspired by the "nappine" (tassels), typically used to close curtains and adorn Venetian salons in the old days. Ten different tassel shapes have been stylised by disassembling and simplifying these decorative objects.

DESIGN BY
MARCO ZITO

SUSPENSION
APPLIQUE

NAPPE C5











NAPPE APP N4



NAPPE APP N2





NAPPE XL2
NAPPE XL1
NAPPE XL3





NAPPE XL1

Nappe

Struttura in metallo verniciato con astine di metallo o Pyrex. Diffusori in Pyrex. Illuminazione a LED.

Painted metal frame with metal or Pyrex rods. Pyrex diffusers. Led Lighting.

Lackierte Metallstruktur mit Metall- oder Pyrex-Stäben. Pyrex-Diffusoren. LED-Beleuchtung.

Estructura de metal pintado con varillas de metal o Pyrex. Difusores en Pyrex. Iluminación LED.

Structure en metal coloré, avec métal ou Pyrex tige. Diffuseur en Pyrex. Eclairage en LED.

Окрашенная металлическая структура с тонкими металлическими стержнями или с Pyrex. Рассеиватели из Pyrex. Светодиодное освещение.

这种灯具的结构是涂漆的金属, 然而光扩散是小金属棒或玻璃做的。LED 照明。

هيكل معدني مطلي مع قضبان معدنية أو بيركس. ناشرات ضوء بيركس. إضاءة ليد.

TOTAL WHITE

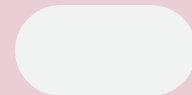

v95 Bianco opaco
Matt white

MIXED COLOURS



V95 + V21 + V51 + V72

TOTAL BLACK

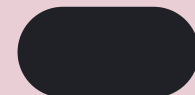

v90 Nero opaco
Matt Black

MIXED WARM



V35 + V70 + V84

METAL BEAMS



v93 Oro verniciato
Painted gold

DIFFUSER



Smoky Pyrex

NAPPE METAL DETAILS

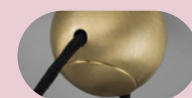

G12 Oro spazzolato
Brushed gold

NAPPE XL METAL DETAILS



F01 Foglia Oro
Gold leaf



G12 Oro spazzolato
Brushed gold



F01 Foglia Oro
Gold leaf



G12 Oro spazzolato
Brushed gold

NAPPE N0

ø 7,5 cm / 2.95"
H 34 cm / 13.38"

INTEGRATED LED LIGHTING

5,4 W CRI>90
3000 K - 688 NOMINAL LM
DIMM NO

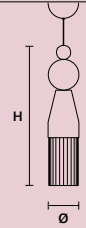

NAPPE N1

ø 15 cm / 5.90"
H 36 cm / 14.17"

INTEGRATED LED LIGHTING

5,4 W CRI>90
3000 K - 688 NOMINAL LM
DIMM NO

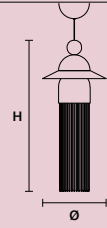

NAPPE N6

ø 15 cm / 5.90"
H 32 cm / 12.59"

INTEGRATED LED LIGHTING

5,4 W CRI>90
3000 K - 688 NOMINAL LM
DIMM NO

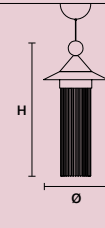

NAPPE N7

ø 7,5 cm / 2.95"
H 34 cm / 13.38"

INTEGRATED LED LIGHTING

5,4 W CRI>90
3000 K - 688 NOMINAL LM
DIMM NO

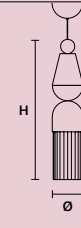

NAPPE N8

ø 15 cm / 5.90"
H 39 cm / 15.35"

INTEGRATED LED LIGHTING

5,4 W CRI>90
3000 K - 688 NOMINAL LM
DIMM NO

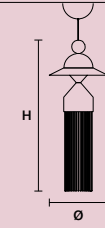

NAPPE N9

ø 7,5 cm / 2.95"
H 39 cm / 15.35"

INTEGRATED LED LIGHTING

5,4 W CRI>90
3000 K - 688 NOMINAL LM
DIMM NO

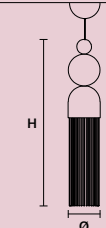

NAPPE N2

ø 15 cm / 5.90"
H 40 cm / 15.74"

INTEGRATED LED LIGHTING

5,4 W CRI>90
3000 K - 688 NOMINAL LM
DIMM NO

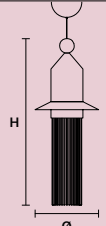

NAPPE N3

ø 7,5 cm / 2.95"
H 36 cm / 14.17"

INTEGRATED LED LIGHTING

5,4 W CRI>90
3000 K - 688 NOMINAL LM
DIMM NO

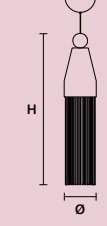

NAPPE APP N4

L 7,5 cm / 2.95"
SP 14 cm / 5.51"
H 40 cm / 15.74"

INTEGRATED LED LIGHTING

5,4 W CRI>90
3000 K - 688 NOMINAL LM

DIMM NO

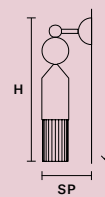

NAPPE APP N2

L 15 cm / 5.90"
SP 18 cm / 7.08"
H 42 cm / 16.53"

INTEGRATED LED LIGHTING

5,4 W CRI>90
3000 K - 688 NOMINAL LM

DIMM NO

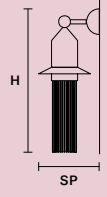

NAPPE XL1

ø 30 cm / 11.81"
H 125 cm / 49.21"

INTEGRATED LED LIGHTING

UP 6,6 W CRI>90
3000 K - 1150 NOMINAL LM
DOWN 9,2 W CRI>90
3000 K - 1450 NOMINAL LM
DIMM 1-10V + DALI + PUSH

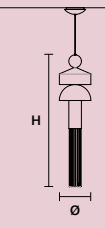

NAPPE XL2

ø 35 cm / 13.77"
H 135 cm / 53.14"

INTEGRATED LED LIGHTING

UP 6,6 W CRI>90
3000 K - 1150 NOMINAL LM
DOWN 9,2 W CRI>90
3000 K - 1450 NOMINAL LM
DIMM 1-10V + DALI + PUSH

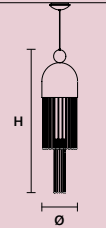

NAPPE N4

ø 7,5 cm / 2.95"
H 38 cm / 14.96"

INTEGRATED LED LIGHTING

5,4 W CRI>90
3000 K - 688 NOMINAL LM
DIMM NO

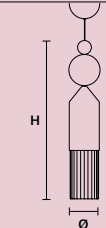

NAPPE N5

ø 15 cm / 5.90"
H 40 cm / 15.74"

INTEGRATED LED LIGHTING

5,4 W CRI>90
3000 K - 688 NOMINAL LM
DIMM NO

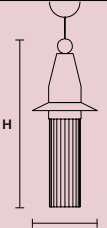

NAPPE XL3

ø 30 cm / 11.81"
H 110 cm / 43.30"

INTEGRATED LED LIGHTING

12,2 W CRI>90
3000 K - 2000 NOMINAL LM

DIMM 1-10V + DALI + PUSH

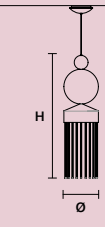

NAPPE C3

ø 30 cm / 11.81"
H 110 cm / 43.30"

INTEGRATED LED LIGHTING

3 x 16,2 W CRI>90
3000 K - 2064 NOMINAL LM

DIMM 1-10V + PUSH

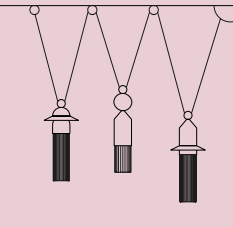

NAPPE C5

ø 30 cm / 11.81"
H 110 cm / 43.30"

INTEGRATED LED LIGHTING

5 x 27 W CRI>90
3000 K - 3440 NOMINAL LM

DIMM 1-10V + PUSH

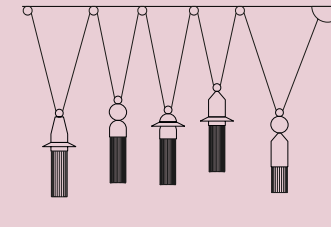

NAPPE C10

ø 30 cm / 11.81"
H 110 cm / 43.30"

INTEGRATED LED LIGHTING

10 x 54 W CRI>90
3000 K - 6880 NOMINAL LM

DIMM 1-10V + PUSH + DALI

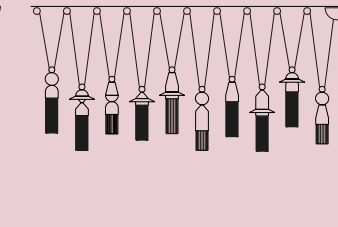

For the US market, refer to the relevant price list.

NAPPE C3 LN 75 

L 75 cm / 29.52"
 SP 20 cm / 7.87"
 H MAX 155 cm / 61.02"

INTEGRATED LED LIGHTING
 3 x 16,2 W CRI>90
 3000 K - 2064 NOMINAL LM

DIMM 1-10V + PUSH

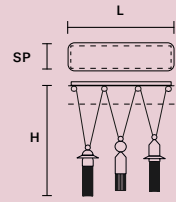



NAPPE C3 LN 125 

L 125 cm / 49.21"
 SP 20 cm / 7.87"
 H MAX 155 cm / 61.02"

INTEGRATED LED LIGHTING
 3 x 16,2 W CRI>90
 3000 K - 2064 NOMINAL LM

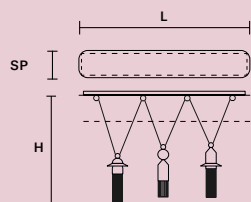
DIMM 1-10V + PUSH



NAPPE C5 LN 175 

L 175 cm / 68.89"
 SP 20 cm / 7.87"
 H MAX 155 cm / 61.02"

INTEGRATED LED LIGHTING
 5 x 27 W CRI>90
 3000 K - 3440 NOMINAL LM

DIMM 1-10V + PUSH

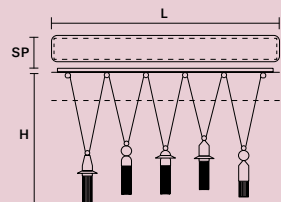



NAPPE C3 RD 40 

ø 40 cm / 15.74"
 H MAX 155 cm / 61.02"

INTEGRATED LED LIGHTING
 3 x 16,2 W CRI>90
 3000 K - 2064 NOMINAL LM

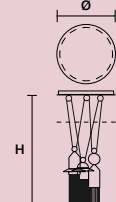
DIMM 1-10V + PUSH





NAPPE C3 RD 60 

ø 60 cm / 23.62"
 H MAX 155 cm / 61.02"

INTEGRATED LED LIGHTING
 3 x 16,2 W CRI>90
 3000 K - 2064 NOMINAL LM

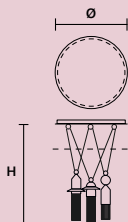
DIMM 1-10V + PUSH



NAPPE C5 RD 80 

ø 80 cm / 31.49"
 H MAX 155 cm / 61.02"

INTEGRATED LED LIGHTING
 5 x 27 W CRI>90
 3000 K - 3440 NOMINAL LM

DIMM 1-10V + PUSH

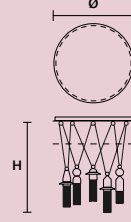

SUGGESTED CONFIGURATION FOR C3 

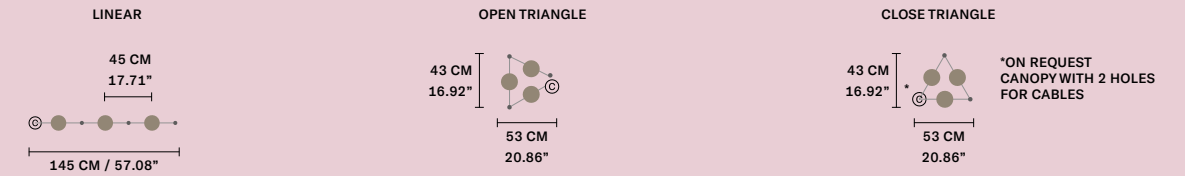

SUGGESTED CONFIGURATION FOR C5 

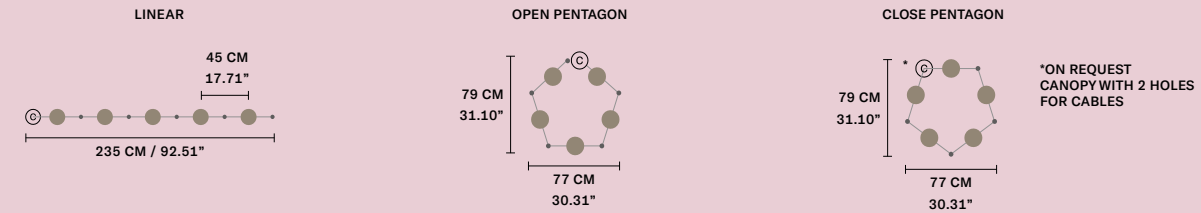

SUGGESTED CONFIGURATION FOR C10 

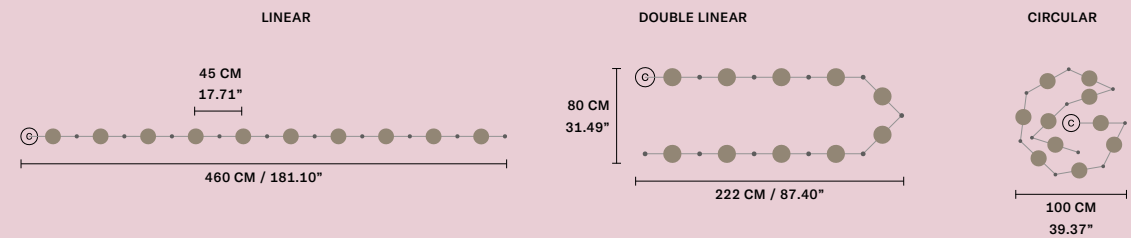

Olà

IT Un gioiello di design che nasce da una sintesi di esperienza e creatività. Progettata più di dieci anni fa dal laboratorio creativo Masiero, con il contrasto tra la sua semplice struttura in metallo e la lussuosa cascata di pendenti, Olà è un'icona Masiero.

EN A jewel of design born from a synthesis of experience and creativity. Designed more than a decade ago by Masiero's creative atelier, the contrast between its simple metal frame and luxurious cascade of pendants makes Olà a Masiero icon.

OLÀ S6 90

DESIGN BY
MASIERO LAB

SUSPENSION
CEILING
APPLIQUE
TABLE LAMP
FLOOR LAMP







OLA TL2



OLÀ S6 90



OLÀ S6 OV 160



OLÀ PL6 90



OLÀ S6 40



OLÀ STL2





OLÀ A1 OV 50



OLÀ C3 LN 75

OLÀ S6 90



OLÀ A2 OV 50

Olà

Struttura in metallo verniciato con pendagli.

Painted metal frame with pendants.

Gestell aus lackiertem Metall mit Behang.

Estructura de metal pintado con colgantes.

Structure en métal verni avec pampilles.

Металлический окрашенный каркас с подвесками.

这种灯具的结构是涂漆的金属, 而且它有水晶吊坠们。

هيكل معدني مطلي مع دلايات.



F01 Gold leaf frame amber pendants



F02 Silver leaf frame transp. pendants



F03 Copper leaf frame copper pendants



G01 Burnished frame amber pendants



v30 Oxide red frame cold pendants



v50 Blue navy frame amber pendants



v83 Matt bronze frame warm pendants

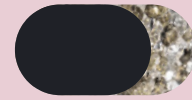

v90 Matt black frame smoky pendants



v95 Matt white frame cold pendants



TRANSPARENT PENDANTS



AMBER PENDANTS



COPPER PENDANTS



SMOKY PENDANTS



COLD PENDANTS



WARM PENDANTS

For the US market, refer to the relevant price list.

OLÀ S12 120

ø 120 cm / 47.24"
H 20 cm / 7.87"

STANDARD LIGHTING

12x E27x20 W MAX (NOT INCL.)
USA 12x E26x60 W MAX (NOT INCL.)

INTEGRATED LED LIGHTING

UP 15,6 W CRI>95
3000 K – 1856 NOMINAL LM
DOWN 62,4 W CRI>95
3000 K – 7425 NOMINAL LM
DIMM 1-10V

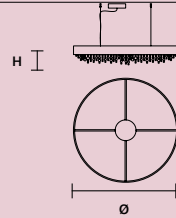

OLÀ S6 60

ø 60 cm / 23.62"
H 20 cm / 7.87"

STANDARD LIGHTING

6x E27x20 W MAX (NOT INCL.)
USA 6x E26x60 W MAX (NOT INCL.)

INTEGRATED LED LIGHTING

UP 7,8 W CRI>95
3000 K – 928 NOMINAL LM
DOWN 23,4 W CRI>95
3000 K – 2784 NOMINAL LM
DIMM 1-10V

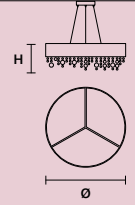

OLÀ S2 15

ø 15 cm / 5.90"
H 26 cm / 10.23"

STANDARD LIGHTING

2x G9x10 W MAX (NOT INCL.)
USA 1x E12x40 W MAX (NOT INCL.)

INTEGRATED LED LIGHTING

DOWN 7,5 W CRI>90
3000 K – 1080 NOMINAL LM
DIMM 1-10V + PUSH

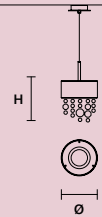

OLÀ S6 90

ø 90 cm / 35.43"
H 20 cm / 7.87"

STANDARD LIGHTING

8x E27x20 W MAX (NOT INCL.)
USA 8x E26x60 W MAX (NOT INCL.)

INTEGRATED LED LIGHTING

UP 10,4 W CRI>95
3000 K – 1236 NOMINAL LM
DOWN 31,2 W CRI>95
3000 K – 3708 NOMINAL LM
DIMM 1-10V



OLÀ S6 40

ø 40 cm / 15.74"
H 20 cm / 7.87"

STANDARD LIGHTING

6x E14x10 W MAX (NOT INCL.)
USA 6x E12x40 W MAX (NOT INCL.)

INTEGRATED LED LIGHTING

UP 13,7 W CRI>95
3000 K – 1625 NOMINAL LM
DOWN 13,7 W CRI>95
3000 K – 1625 NOMINAL LM
DIMM 1-10V



OLÀ S8 OV 210

L 210 cm / 82.67"
SP 20 cm / 7.87"
H 20 cm / 7.87"

STANDARD LIGHTING

8x E14x10 W MAX (NOT INCL.)
USA 8x E12x40 W MAX (NOT INCL.)

INTEGRATED LED LIGHTING

UP 15,6 W CRI>95
3000 K – 1856 NOMINAL LM
DOWN 70,2 W CRI>95
3000 K – 8560 NOMINAL LM
DIMM 1-10V

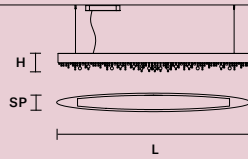

OLÀ S6 OV 160

L 160 cm / 63.00"
SP 14 cm / 5.50"
H 20 cm / 7.87"

STANDARD LIGHTING

6x E14x10 W MAX (NOT INCL.)
USA 6x E12x40 W MAX (NOT INCL.)

INTEGRATED LED LIGHTING

UP 10,4 W CRI>95
3000 K – 1236 NOMINAL LM
DOWN 50,7 W CRI>95
3000 K – 6033 NOMINAL LM
DIMM 1-10V

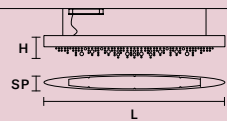

OLÀ PL12 120

ø 120 cm / 47.24"
H 26 cm / 10.23"

STANDARD LIGHTING

12x E27x20 W MAX (NOT INCL.)
USA 12x E26x60 W MAX (NOT INCL.)

INTEGRATED LED LIGHTING

DOWN 62,4 W CRI>95
3000 K – 7425 NOMINAL LM
DIMM 1-10V

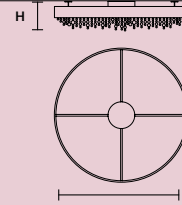

OLÀ PL8 OV 210

L 210 cm / 82.67"
SP 20 cm / 7.87"
H 26 cm / 10.23"

STANDARD LIGHTING

8x E14x10 W MAX (NOT INCL.)
USA 8x E12x40 W MAX (NOT INCL.)

INTEGRATED LED LIGHTING

DOWN 70,2 W CRI>95
3000 K – 8560 NOMINAL LM
DIMM 1-10V

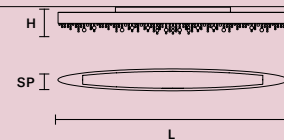

OLÀ S4 OV 100

L 100 cm / 39.37"
SP 13 cm / 5.12"
H 20 cm / 7.87"

STANDARD LIGHTING

4x E14x10 W MAX (NOT INCL.)
USA 4x E12x40 W MAX (NOT INCL.)

INTEGRATED LED LIGHTING

UP 5,2 W CRI>95
3000 K – 618 NOMINAL LM
DOWN 25,35 W CRI>95
3000 K – 3016 NOMINAL LM
DIMM 1-10V

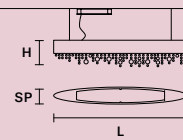

OLÀ PL6 90

ø 90 cm / 35.50"
H 26 cm / 10.23"

STANDARD LIGHTING

8x E27x20 W MAX (NOT INCL.)
USA 8x E26x60 W MAX (NOT INCL.)

INTEGRATED LED LIGHTING

DOWN 31,2 W CRI>95
3000 K – 3708 NOMINAL LM
DIMM 1-10V

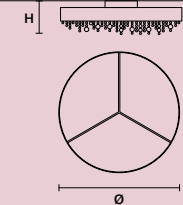

OLÀ PL6 OV 160

L 160 cm / 62.99"
SP 13 cm / 5.12"
H 26 cm / 10.23"

STANDARD LIGHTING

6x E14x10 W MAX (NOT INCL.)
USA 6x E12x40 W MAX (NOT INCL.)

INTEGRATED LED LIGHTING

DOWN 50,7 W CRI>95
3000 K – 6033 NOMINAL LM
DIMM 1-10V

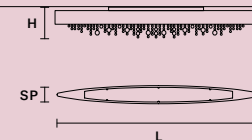

OLÀ S2 OV 50

L 50 cm / 19.69"
SP 8 cm / 3.14"
H 18 cm / 7.09"

STANDARD LIGHTING

2x E27x20 W MAX (NOT INCL.)
USA 2x E26x60 W MAX (NOT INCL.)

INTEGRATED LED LIGHTING

UP 5,2 W CRI>95
3000 K – 618 NOMINAL LM
DOWN 7,8 W CRI>95
3000 K – 930 NOMINAL LM
DIMM 1-10V + PUSH

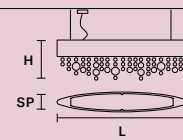

OLÀ PL6 60

ø 60 cm / 23.62"
H 26 cm / 10.23"

STANDARD LIGHTING

6x E27x20 W MAX (NOT INCL.)
USA 6x E26x60 W MAX (NOT INCL.)

INTEGRATED LED LIGHTING

DOWN 23,4 W CRI>95
3000 K – 2784 NOMINAL LM
DIMM 1-10V



OLÀ PL4 OV 100

L 100 cm / 39.37"
SP 13 cm / 5.12"
H 26 cm / 10.23"

STANDARD LIGHTING

4x E14x10 W MAX (NOT INCL.)
USA 4x E12x40 W MAX (NOT INCL.)

INTEGRATED LED LIGHTING

DOWN 25,35 W CRI>95
3000 K – 3016 NOMINAL LM
DIMM 1-10V

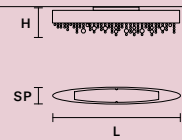

OLÀ S1 OV 30

L 30 cm / 11.81"
SP 7 cm / 2.75"
H 18 cm / 7.09"

STANDARD LIGHTING

1x E14x10 W MAX (NOT INCL.)
USA 1x E12x40 W MAX (NOT INCL.)

INTEGRATED LED LIGHTING

UP 4 W CRI>95
3000 K – 464 NOMINAL LM
DOWN 4 W CRI>95
3000 K – 464 NOMINAL LM
DIMM 1-10V + PUSH



OLÀ PL6 40

ø 40 cm / 15.74"
H 26 cm / 10.23"

STANDARD LIGHTING

6x E14x10 W MAX (NOT INCL.)
USA 6x E12x40 W MAX (NOT INCL.)

INTEGRATED LED LIGHTING

DOWN 13,7 W CRI>95
3000 K – 1625 NOMINAL LM
DIMM 1-10V



OLÀ A6 OV 160

L 160 cm / 62.99"
SP 20 cm / 7.87"
H 20 cm / 7.87"

STANDARD LIGHTING

6x E14x10 W MAX (NOT INCL.)
USA 6x E12x40 W MAX (NOT INCL.)

INTEGRATED LED LIGHTING

UP 10,4 W CRI>95
3000 K – 1236 NOMINAL LM
DOWN 50,7 W CRI>95
3000 K – 6033 NOMINAL LM
DIMM NO

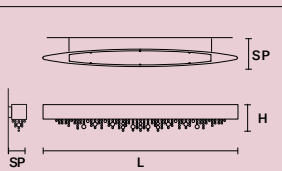

OLÀ A2 OV 70

L 70 cm / 27.56"
 SP 15 cm / 5.90"
 H 20 cm / 7.87"



STANDARD LIGHTING
 2×E27×20 W MAX (NOT INCL.)

USA 2×E26×60 W MAX (NOT INCL.)



INTEGRATED LED LIGHTING
 UP 11,7 W CRI>95
 3000 K – 1390 NOMINAL LM
 DOWN 19,5 W CRI>95
 3000 K – 2300 NOMINAL LM
 DIMM NO

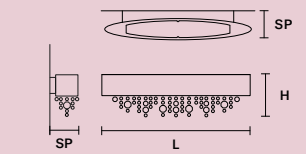

OLÀ STL2

L 50 cm / 19.68"
 SP 24 cm / 9.45"
 H 180 cm / 70.86"



STANDARD LIGHTING
 2×E27×20 W MAX (NOT INCL.)

USA 2×E26×60 W MAX (NOT INCL.)



INTEGRATED LED LIGHTING
 UP 5,2 W CRI>95
 3000 K – 618 NOMINAL LM
 DOWN 7,8 W CRI>95
 3000 K – 930 NOMINAL LM
 DIMM OWN BUTTON

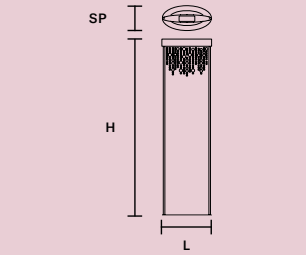

OLÀ A2 OV 50

L 50 cm / 19.68"
 SP 12 cm / 4.72"
 H 18 cm / 7.08"



STANDARD LIGHTING
 2×E27×20 W MAX (NOT INCL.)

USA 2×E26×60 W MAX (NOT INCL.)



INTEGRATED LED LIGHTING
 UP 5,2 W CRI>95
 3000 K – 618 NOMINAL LM
 DOWN 7,8 W CRI>95
 3000 K – 930 NOMINAL LM
 DIMM 1-10V + PUSH

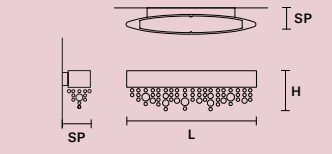

OLÀ A1 OV 30

L 30 cm / 11.81"
 SP 10 cm / 3.94"
 H 18 cm / 7.08"



STANDARD LIGHTING
 1×E14×10 W MAX (NOT INCL.)

USA 1×E12×40 W MAX (NOT INCL.)



INTEGRATED LED LIGHTING
 UP 4 W CRI>95
 3000 K – 464 NOMINAL LM
 DOWN 4 W CRI>95
 3000 K – 464 NOMINAL LM
 DIMM 1-10V + PUSH

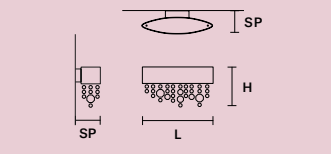

OLÀ TL2

L 50 cm / 19.68"
 SP 16 cm / 6.30"
 H 50 cm / 19.68"



STANDARD LIGHTING
 2×E27×20 W MAX (NOT INCL.)

USA 2×E26×60 W MAX (NOT INCL.)



INTEGRATED LED LIGHTING
 UP 5,2 W CRI>95
 3000 K – 618 NOMINAL LM
 DOWN 7,8 W CRI>95
 3000 K – 930 NOMINAL LM
 DIMM OWN BUTTON

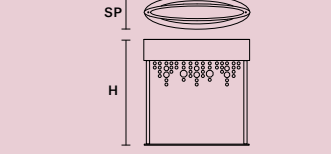

OLÀ C3 LN 75

L 75 cm / 29.52"
 SP 20 cm / 7.87"
 H MAX 180 cm / 70.86"



STANDARD LIGHTING
 6×G9×10 W MAX (NOT INCL.)

USA 3×E12×40 W MAX (NOT INCL.)

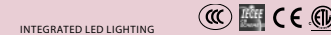

INTEGRATED LED LIGHTING
 DOWN 22,5 W CRI>90
 3000 K – 3240 NOMINAL LM

DIMM 1-10V + PUSH

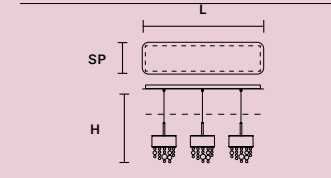

OLÀ C3 RD 40

ø 40 cm / 15.74"
 H MAX 180 cm / 70.86"



STANDARD LIGHTING
 6×G9×10 W MAX (NOT INCL.)

USA 3×E12×40 W MAX (NOT INCL.)

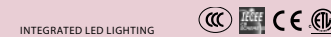

INTEGRATED LED LIGHTING
 DOWN 22,5 W CRI>90
 3000 K – 3240 NOMINAL LM

DIMM 1-10V + PUSH

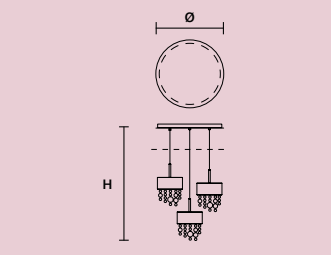

OLÀ C5 LN 125

L 125 cm / 49.21"
 SP 20 cm / 7.87"
 H MAX 180 cm / 70.86"



STANDARD LIGHTING
 10×G9×10 W MAX (NOT INCL.)

USA 5×E12×40 W MAX (NOT INCL.)

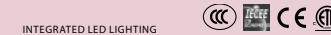

INTEGRATED LED LIGHTING
 DOWN 37,5 W CRI>90
 3000 K – 5400 NOMINAL LM

DIMM 1-10V + DALI + PUSH

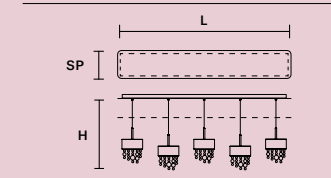

OLÀ C5 RD 60

ø 60 cm / 23.62"
 H MAX 180 cm / 70.86"



STANDARD LIGHTING
 10×G9×10 W MAX (NOT INCL.)

USA 5×E12×40 W MAX (NOT INCL.)

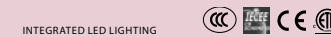

INTEGRATED LED LIGHTING
 DOWN 37,5 W CRI>90
 3000 K – 5400 NOMINAL LM

DIMM 1-10V + DALI + PUSH

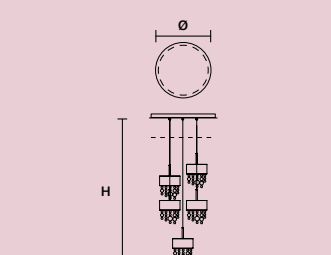

OLÀ C7 LN 175

L 175 cm / 68.89"
 SP 20 cm / 7.87"
 H MAX 180 cm / 70.86"



STANDARD LIGHTING
 14×G9×10 W MAX (NOT INCL.)

USA 7×E12×40 W MAX (NOT INCL.)

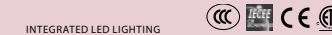

INTEGRATED LED LIGHTING
 DOWN 52,5 W CRI>90
 3000 K – 7560 NOMINAL LM

DIMM 1-10V + DALI + PUSH

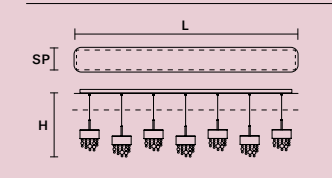

OLÀ C7 RD 80

ø 80 cm / 31.49"
 H MAX 180 cm / 70.86"



STANDARD LIGHTING
 14×G9×10 W MAX (NOT INCL.)

USA 7×E12×40 W MAX (NOT INCL.)

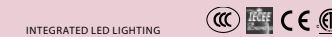

INTEGRATED LED LIGHTING
 DOWN 52,5 W CRI>90
 3000 K – 7560 NOMINAL LM

DIMM 1-10V + DALI + PUSH

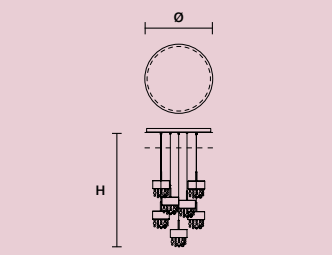

* ETL only for US market.

Ribbon

IT Ribbon parla di leggerezza contemporanea delle linee, purezza dei materiali e minimalismo dei colori. Questo è Ribbon, dove il metallo cinge il vetro come chiffon bianco avvolto da un nastro nero dalle abili mani di una sarta.

EN Ribbon expresses contemporary lightness in its lines, purity in its materials and minimalism in its colours. This is Ribbon, where metal encircles the glass like white chiffon wrapped in a black ribbon by the skilled hands of a seamstress.

DESIGN BY
ORIANO FAVARETTO

SUSPENSION
APPLIQUE
TABLE LAMP
FLOOR LAMP

RIBBON S80





RIBBON A37







RIBBON A65



RIBBON S150



Ribbon

Telaio in metallo verniciato. Vetri in piastra. Illuminazione a LED.

Painted metal frame. Plate glasses. LED lighting.

Struktur aus lackiertem Metall. Glas aus gegossenen Glasplatten. LED-Beleuchtung.

Marco de metal pintado. Vidrio en placa. Iluminación LED.

Structure en métal peint. Verre plat. LED éclairage.

Окрашенный металлический каркас. Венецианское рельефное стекло. Светодиод.

这种灯具的结构是涂漆的金属，而且结构也有一些特别的意大利制造玻璃线条们。LED照明。

إطار معدني مطلي. زجاج في لوح. إضاءة ليد.

RIBBON S200	
L	200 cm / 78.74"
SP	8 cm / 3.14"
H	33 cm / 12.99"
INTEGRATED LED LIGHTING	
UP	21.1 W CRI>95 3000 K – 2781 NOMINAL LM
DOWN	44.46 W CRI>95 3000 K – 5871 NOMINAL LM
DIMM	0-10V



RIBBON S150	
L	150 cm / 59.05"
SP	8 cm / 3.14"
H	33 cm / 12.99"
INTEGRATED LED LIGHTING	
UP	17 W CRI>95 3000 K – 1854 NOMINAL LM
DOWN	33.5 W CRI>95 3000 K – 4326 NOMINAL LM
DIMM	0-10V

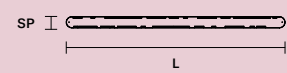

RIBBON S100	
L	100 cm / 39.37"
SP	8 cm / 3.14"
H	33 cm / 12.99"
INTEGRATED LED LIGHTING	
UP	9.36 W CRI>95 3000 K – 1236 NOMINAL LM
DOWN	21.1 W CRI>95 3000 K – 2781 NOMINAL LM
DIMM	0-10V

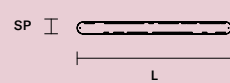

RIBBON STL	
L	38 cm / 14.96"
SP	16 cm / 6.29"
H	160 cm / 62.99"
INTEGRATED LED LIGHTING	
UP	6 W CRI>95 3000 K – 860 NOMINAL LM
DOWN	6 W CRI>95 3000 K – 860 NOMINAL LM
DIMM	OWN BUTTON

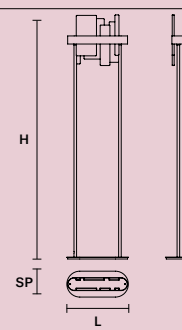

RIBBON S70	
L	70 cm / 27.55"
SP	8 cm / 3.14"
H	33 cm / 12.99"
INTEGRATED LED LIGHTING	
UP	7 W CRI>95 3000 K – 927 NOMINAL LM
DOWN	15 W CRI>95 3000 K – 2008 NOMINAL LM
DIMM	0-10V

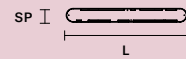
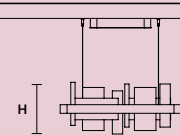

RIBBON S80	
L	80 cm / 31.49"
SP	80 cm / 31.49"
H	33 cm / 12.99"
INTEGRATED LED LIGHTING	
UP	28.1 W CRI>95 3000 K – 4326 NOMINAL LM
DOWN	60.85 W CRI>95 3000 K – 7416 NOMINAL LM
DIMM	0-10V

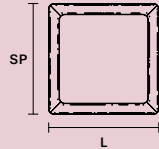
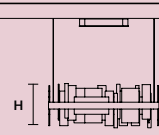

RIBBON S50	
L	50 cm / 19.68"
SP	50 cm / 19.68"
H	33 cm / 12.99"
INTEGRATED LED LIGHTING	
UP	15.21 W CRI>95 3000 K – 2008 NOMINAL LM
DOWN	32.76 W CRI>95 3000 K – 4326 NOMINAL LM
DIMM	0-10V

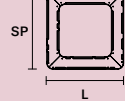
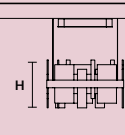

v90 Nero opaco
Matt black



g01 Brunito*
Burnished

*NOT AVAILABLE FOR RIBBON S80
AND RIBBON S50



Vetro trasparente
Transparent glass

RIBBON A65	
L	65 cm / 25.59"
SP	10 cm / 3.93"
H	33 cm / 12.99"
INTEGRATED LED LIGHTING	
UP	5.8 W CRI>95 3000 K – 849 NOMINAL LM
DOWN	5.8 W CRI>95 3000 K – 849 NOMINAL LM
DIMM	1-10V + PUSH

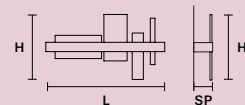

RIBBON A37	
L	37 cm / 14.56"
SP	10 cm / 3.93"
H	33 cm / 12.99"
INTEGRATED LED LIGHTING	
UP	3.51 W CRI>95 3000 K – 463 NOMINAL LM
DOWN	3.51 W CRI>95 3000 K – 463 NOMINAL LM
DIMM	1-10V + PUSH

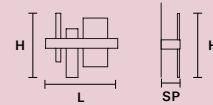

RIBBON TL	
L	38 cm / 14.96"
SP	16 cm / 6.29"
H	48 cm / 18.89"
INTEGRATED LED LIGHTING	
UP	6 W CRI>95 3000 K – 860 NOMINAL LM
DOWN	6 W CRI>95 3000 K – 860 NOMINAL LM
DIMM	OWN BUTTON

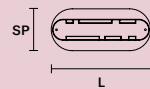
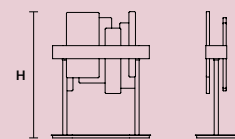

For the US market, refer to the relevant price list.

Crek

IT Crek è espressione di creatività e della capacità veneziana di lavorare il vetro in modo inimitabile al mondo. La forma geometrica ed il vetro effetto cristallo di Rocca donano a Crek le sembianze di una meravigliosa scultura di ghiaccio, che come un Iglù suscita una sensazione di calore e sicurezza.

EN Crek expresses the Venetian ability to work with glass in a way unparalleled anywhere else in the world. With its geometric shape and rock crystal effect glass, Crek resembles a wonderful ice sculpture and evokes the warm, safe sensation of an igloo.

DESIGN BY
MASIERO LAB

SUSPENSION
APPLIQUE
TABLE LAMP
FLOOR LAMP

CREK S5







CREK TL 6



CREK STL 6





CREK A2 G



CREK TL 1

Crek

Telaio in metallo con listelli di vetro «Crek» (ispirato al cristallo di rocca).

Metal frame with «Crek» glass panels (inspired by rock crystal).

Metallrahmen mit «Crek» Glasplatten (inspiriert von dem Bergkristall).

Marco de metal con listones de vidrio «Crek» (inspirado al cristal de roca).

Structure en métal avec tiges de verre «Crek» (inspiré du cristal de roche).

Металлический каркас со стеклом «Crek» (имитация горного хрусталя).

这种灯具具有金属的结构, 而且它有«CREK» 玻璃条 (类似白水晶)。

إطار معدني بألواح زجاجية «كريك» مستوحاة من الكريستال الصخري).



G18 Ottone spazzolato
Brushed brass



Vetro Crek
Crek glass

CREK S14			
L	123 cm / 48.42"		
SP	31.5 cm / 12.40"		
H	40 cm / 15.74"		
STANDARD LIGHTING			
	14×E14×10 W MAX (NOT INCL.)		
USA	14×E12×40 W MAX (NOT INCL.)		

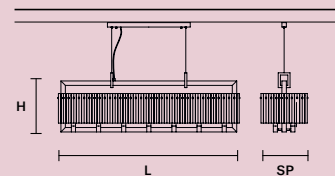

CREK S10			
L	95 cm / 37.40"		
SP	31.5 cm / 12.40"		
H	40 cm / 15.74"		
STANDARD LIGHTING			
	10×E14×10 W MAX (NOT INCL.)		
USA	10×E12×40 W MAX (NOT INCL.)		

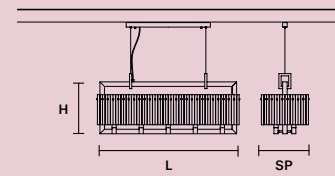

CREK S5			
STANDARD LIGHTING			
	5×E14×10 W MAX (NOT INCL.)		
USA	5×E12×40 W MAX (NOT INCL.)		

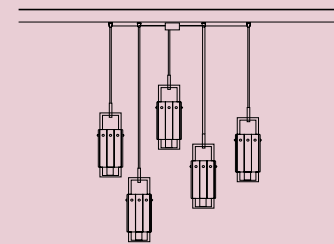

CREK C3 LN 75			
L	75 cm / 29.52"		
SP	20 cm / 7.87"		
H MAX	195 cm / 76.77"		
STANDARD LIGHTING			
	3×E14×10 W MAX (NOT INCL.)		
USA	3×E12×40 W MAX (NOT INCL.)		

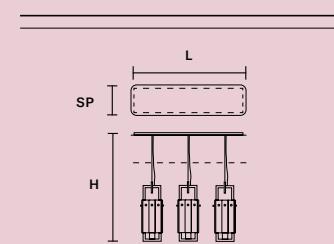

CREK C5 LN 125			
L	125 cm / 49.21"		
SP	20 cm / 7.87"		
H MAX	195 cm / 76.77"		
STANDARD LIGHTING			
	5×E14×10 W MAX (NOT INCL.)		
USA	5×E12×40 W MAX (NOT INCL.)		

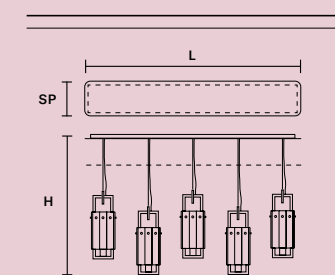

CREK C3 RD 60			
ø	60 cm / 23.62"		
H MAX	195 cm / 76.77"		
STANDARD LIGHTING			
	3×E14×10 W MAX (NOT INCL.)		
USA	3×E12×40 W MAX (NOT INCL.)		

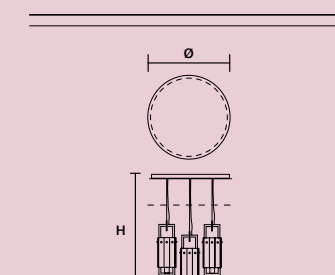

CREK C5 RD 80			
ø	80 cm / 31.49"		
H MAX	195 cm / 76.77"		
STANDARD LIGHTING			
	5×E14×10 W MAX (NOT INCL.)		
USA	5×E12×40 W MAX (NOT INCL.)		

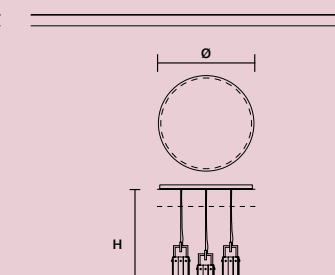

CREK S1			
L	15.5 cm / 6.10"		
SP	15.5 cm / 6.10"		
H	40 cm / 15.74"		
STANDARD LIGHTING			
	1×E14×10 W MAX (NOT INCL.)		
USA	1×E12×40 W MAX (NOT INCL.)		

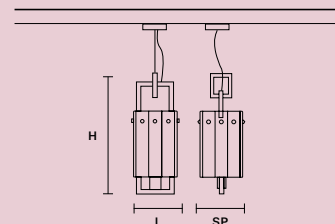

CREK A2				
L	22.5 cm / 8.85"			
SP	13 cm / 5.11"			
H	45 cm / 17.71"			
STANDARD LIGHTING				
	2×E14×10 W MAX (NOT INCL.)			
USA	2×E12×40 W MAX (NOT INCL.)			

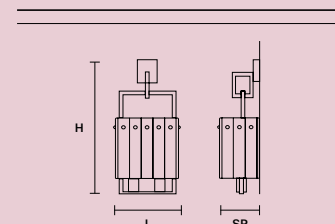

CREK A1				
L	15.5 cm / 6.10"			
SP	13 cm / 5.11"			
H	45 cm / 17.71"			
STANDARD LIGHTING				
	1×E14×10 W MAX (NOT INCL.)			
USA	1×E12×40 W MAX (NOT INCL.)			

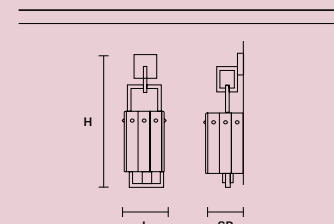

CREK TL 1				*
L	15.5 cm / 6.10"			
SP	15.5 cm / 6.10"			
H	41.5 cm / 17.71"			
STANDARD LIGHTING				
	1×E14×10 W MAX (NOT INCL.)			
USA	1×E12×40 W MAX (NOT INCL.)			

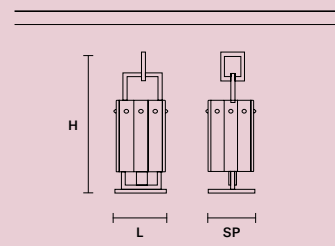

CREK TL 6			
L	45 cm / 17.70"		
SP	31 cm / 12.20"		
H	41 cm / 16.10"		
STANDARD LIGHTING			
	6×E14×10 W MAX (NOT INCL.)		
USA	6×E12×40 W MAX (NOT INCL.)		

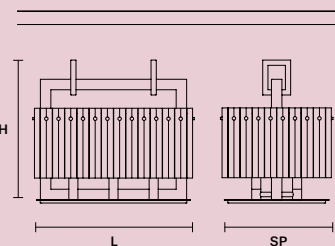

CREK STL 6			
L	45 cm / 17.70"		
SP	32 cm / 12.60"		
H	160 cm / 63.00"		
STANDARD LIGHTING			
	6×E14×10 W MAX (NOT INCL.)		
USA	6×E12×40 W MAX (NOT INCL.)		

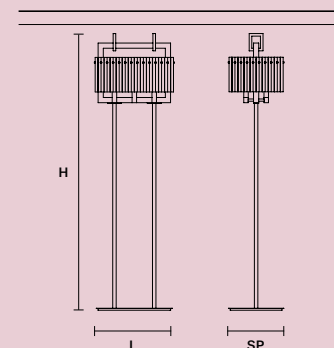

For the US market, refer to the relevant price list.

* ETL only for US market.

Cubo

CUBO PL COMBO 175

IT Cubo è la sintesi di dinamicità mentale e tradizione. E' un sistema di illuminazione modulare che permette di creare scenari a soffitto o a sospensione grazie alla combinazione di moduli quadrati o rettangolari. Osservando Cubo e dando libero spazio alle tue emozioni, potrai sentire il brusio di una cascata, con l'acqua che si cristallizza diventando un'opera di luce.

EN Cubo is the synthesis of mental vitality and tradition. This modular lighting system can be used to create ceiling or pendant scenarios by combining square or rectangular modules. When you look at Cubo and give free rein to your emotions, you seem to hear the murmur of a waterfall, where the water crystallises to form a work of light.

DESIGN BY
MASIERO LAB

SUSPENSION
CEILING
APPLIQUE







CUBO A LONG



CUBO S LONG R



CUBO PL SQUARE LARGE 20



CUBO PL SQUARE MEDIUM 40
CUBO PL SQUARE MEDIUM 20

CUBO S LONG K



CUBO A SQUARE

Cubo

Struttura in metallo con pendagli in cristallo.

Metal frame with crystal pendants. Gestell aus Metall mit Behang aus Kristall.

Estructura de metal con colgantes de cristal.

Structure en métal avec pampilles en cristal.

Металлический каркас с подвесками из хрусталя.

这种灯具具有金属结构, 而且它有水晶的吊坠们。

هيكل معدني مع دلايات من الكريستال.

PENDANTS



G04 Cromo lucido
Shiny chrome



TR Trasparente
Transparent



SA Zaffiro
Sapphire



AM Ambra
Amber



VI Viola
Violet



RE Rosso
Red



GR Light
Peridot



SM Golden Fumé
Golden Smoky

CUBO S/SQUARE/SMALL 20

L 12.5 cm / 4.92"
SP 12.5 cm / 4.92"
H 20 cm / 7.87"

STANDARD LIGHTING

1×E14×10 W MAX (NOT INCL.)

USA 1×E12×40 W MAX (NOT INCL.)

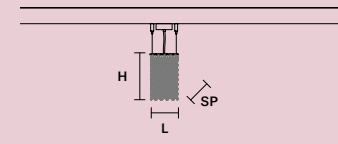

CUBO S/SQUARE/SMALL 40

L 12.5 cm / 4.92"
SP 12.5 cm / 4.92"
H 40 cm / 15.74"

STANDARD LIGHTING

1×E14×10 W MAX (NOT INCL.)

USA 1×E12×40 W MAX (NOT INCL.)

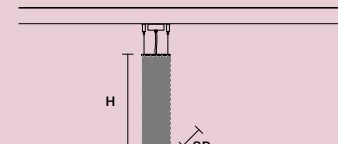

CUBO S/SQUARE/SMALL 60

L 12.5 cm / 4.92"
SP 12.5 cm / 4.92"
H 60 cm / 23.62"

STANDARD LIGHTING

3×E14×10 W MAX (NOT INCL.)

USA 3×E12×40 W MAX (NOT INCL.)

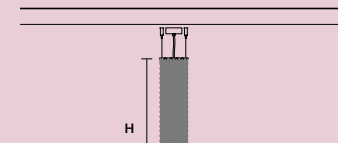

CUBO S/SQUARE/SMALL 80

L 12.5 cm / 4.92"
SP 12.5 cm / 4.92"
H 80 cm / 31.49"

STANDARD LIGHTING

3×E14×10 W MAX (NOT INCL.)

USA 3×E12×40 W MAX (NOT INCL.)

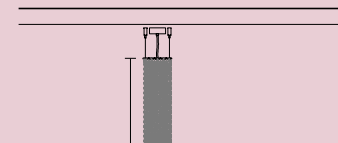

CUBO S/SQUARE/MEDIUM 20

L 25 cm / 9.84"
SP 25 cm / 9.84"
H 20 cm / 7.87"

STANDARD LIGHTING

4×E14×10 W MAX (NOT INCL.)

USA 4×E12×40 W MAX (NOT INCL.)

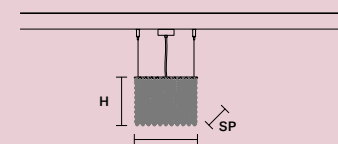

CUBO S/SQUARE/MEDIUM 40

L 25 cm / 9.84"
SP 25 cm / 9.84"
H 40 cm / 15.74"

STANDARD LIGHTING

7×E14×10 W MAX (NOT INCL.)

USA 7×E12×40 W MAX (NOT INCL.)

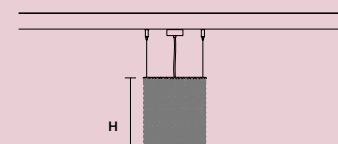

CUBO S/SQUARE/MEDIUM 60

L 25 cm / 9.84"
SP 25 cm / 9.84"
H 60 cm / 23.62"

STANDARD LIGHTING

8×E14×10 W MAX (NOT INCL.)

USA 8×E12×40 W MAX (NOT INCL.)

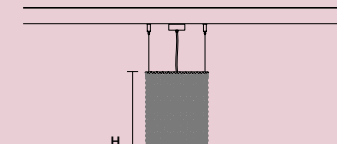

CUBO S/SQUARE/MEDIUM 80

L 25 cm / 9.84"
SP 25 cm / 9.84"
H 80 cm / 31.49"

STANDARD LIGHTING

10×E14×10 W MAX (NOT INCL.)

USA 10×E12×40 W MAX (NOT INCL.)

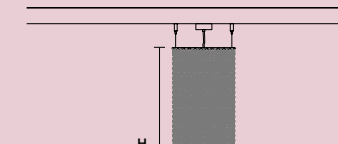

CUBO S/SQUARE/LARGE 20

L 50 cm / 19.68"
SP 50 cm / 19.68"
H 20 cm / 7.87"

STANDARD LIGHTING

12×E14×10 W MAX (NOT INCL.)

USA 12×E12×40 W MAX (NOT INCL.)

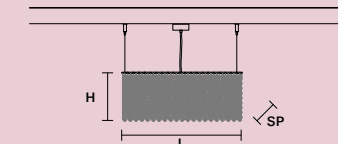

CUBO S/SQUARE/LARGE 40

L 50 cm / 19.68"
SP 50 cm / 19.68"
H 40 cm / 15.74"

STANDARD LIGHTING

12×E14×10 W MAX (NOT INCL.)

USA 12×E12×40 W MAX (NOT INCL.)

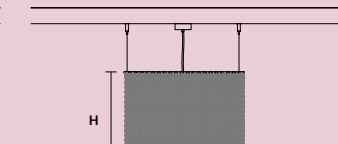

CUBO S/LONG/A

L 50 cm / 19.68"
SP 12.5 cm / 4.92"
H 20 cm / 7.87"

STANDARD LIGHTING

4×E14×10 W MAX (NOT INCL.)

USA 4×E12×40 W MAX (NOT INCL.)

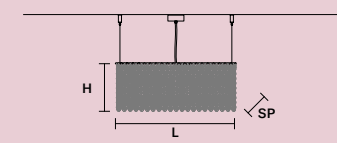

CUBO S/LONG/B

L 50 cm / 19.68"
SP 12.5 cm / 4.92"
H 40 cm / 15.74"

STANDARD LIGHTING

7×E14×10 W MAX (NOT INCL.)

USA 7×E12×40 W MAX (NOT INCL.)

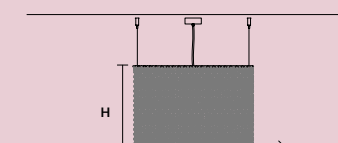

CUBO S/LONG/C

L 50 cm / 19.68"
SP 12.5 cm / 4.92"
H 60 cm / 23.62"

STANDARD LIGHTING

7×E14×10 W MAX (NOT INCL.)

USA 7×E12×40 W MAX (NOT INCL.)

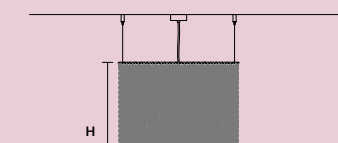

CUBO S/LONG/D

L 75 cm / 29.52"
SP 12.5 cm / 4.92"
H 20 cm / 7.87"

STANDARD LIGHTING

5×E14×10 W MAX (NOT INCL.)

USA 5×E12×40 W MAX (NOT INCL.)

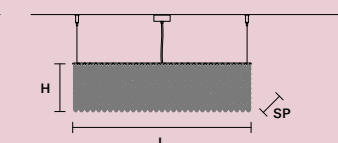

CUBO S/LONG/E

L 75 cm / 29.52"
SP 12.5 cm / 4.92"
H 40 cm / 15.74"

STANDARD LIGHTING

9×E14×10 W MAX (NOT INCL.)

USA 9×E12×40 W MAX (NOT INCL.)

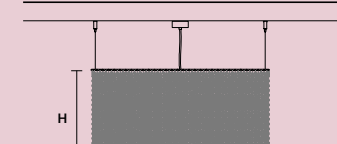

CUBO S/LONG/F

L 75 cm / 29.52"
SP 12.5 cm / 4.92"
H 60 cm / 23.62"

STANDARD LIGHTING

9×E14×10 W MAX (NOT INCL.)

USA 9×E12×40 W MAX (NOT INCL.)

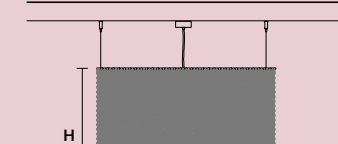

CUBO S/LONG/G

L 100 cm / 39.37"
SP 12.5 cm / 4.92"
H 20 cm / 7.87"

STANDARD LIGHTING

6×E14×10 W MAX (NOT INCL.)

USA 6×E12×40 W MAX (NOT INCL.)

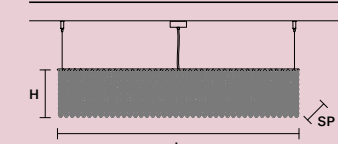

CUBO S/LONG/H

L 100 cm / 39.37"
SP 12.5 cm / 4.92"
H 40 cm / 15.74"

STANDARD LIGHTING

11×E14×10 W MAX (NOT INCL.)

USA 11×E12×40 W MAX (NOT INCL.)

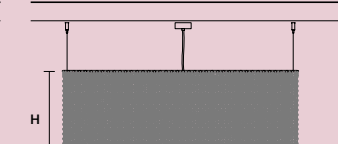

For the US market, refer to the relevant price list.

CUBO S/LONG/I 

L	100 cm / 39.37"
SP	12.5 cm / 4.92"
H	60 cm / 23.62"

STANDARD LIGHTING

11xE14x10 W MAX (NOT INCL.)

USA 11xE12x40 W MAX (NOT INCL.)

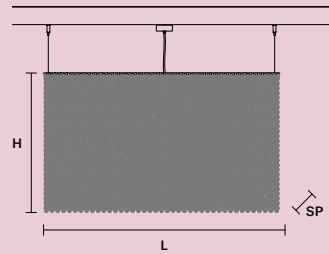

CUBO S/LONG/J 

L	50 cm / 19.68"
SP	25 cm / 9.84"
H	20 cm / 7.87"

STANDARD LIGHTING

8xE14x10 W MAX (NOT INCL.)

USA 8xE12x40 W MAX (NOT INCL.)

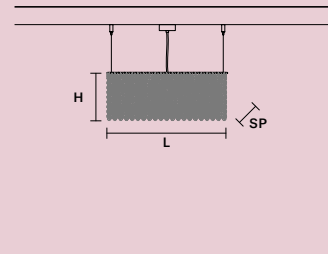

CUBO S/LONG/K 

L	50 cm / 19.68"
SP	25 cm / 9.84"
H	40 cm / 15.74"

STANDARD LIGHTING

12xE14x10 W MAX (NOT INCL.)

USA 12xE12x40 W MAX (NOT INCL.)

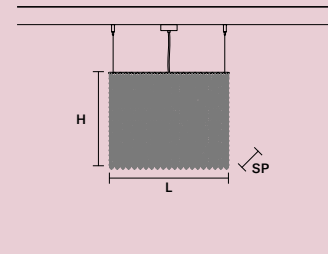

CUBO S/LONG/L 

L	50 cm / 19.68"
SP	25 cm / 9.84"
H	60 cm / 23.62"

STANDARD LIGHTING

12xE14x10 W MAX (NOT INCL.)

USA 12xE12x40 W MAX (NOT INCL.)

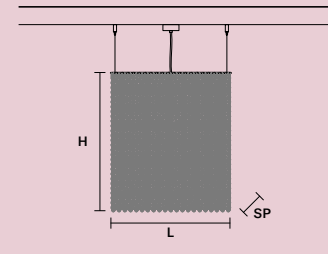

CUBO S/LONG/M 

L	75 cm / 29.52"
SP	25 cm / 9.84"
H	20 cm / 7.87"

STANDARD LIGHTING

9xE14x10 W MAX (NOT INCL.)

USA 9xE12x40 W MAX (NOT INCL.)

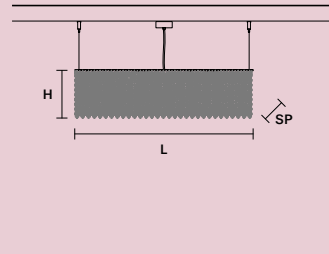

CUBO S/LONG/N 

L	75 cm / 29.52"
SP	25 cm / 9.84"
H	40 cm / 15.74"

STANDARD LIGHTING

17xE14x10 W MAX (NOT INCL.)

USA 17xE12x40 W MAX (NOT INCL.)

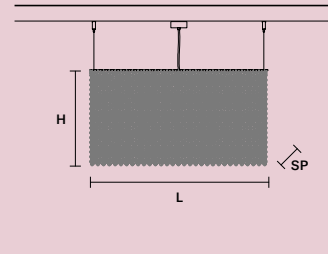

CUBO S/LONG/O 

L	75 cm / 29.52"
SP	25 cm / 9.84"
H	60 cm / 23.62"

STANDARD LIGHTING

17xE14x10 W MAX (NOT INCL.)

USA 17xE12x40 W MAX (NOT INCL.)

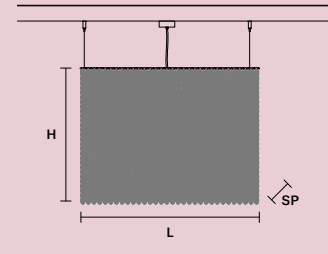

CUBO S/LONG/P 

L	100 cm / 39.37"
SP	25 cm / 9.84"
H	20 cm / 7.87"

STANDARD LIGHTING

12xE14x10 W MAX (NOT INCL.)

USA 12xE12x40 W MAX (NOT INCL.)

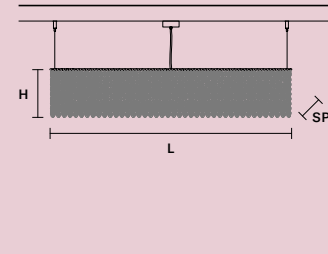

CUBO S/LONG/Q 

L	100 cm / 39.37"
SP	25 cm / 9.84"
H	40 cm / 15.74"

STANDARD LIGHTING

18xE14x10 W MAX (NOT INCL.)

USA 18xE12x40 W MAX (NOT INCL.)

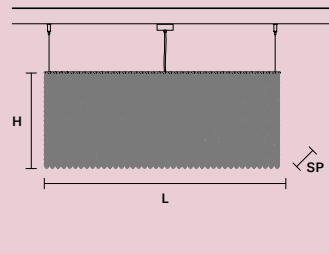

CUBO S/LONG/R 

L	100 cm / 39.37"
SP	25 cm / 9.84"
H	60 cm / 23.62"

STANDARD LIGHTING

18xE14x10 W MAX (NOT INCL.)

USA 18xE12x40 W MAX (NOT INCL.)

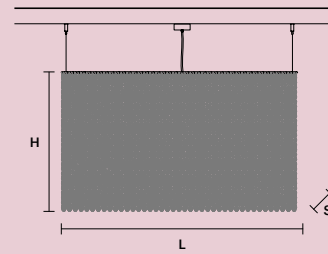

CUBO S/LONG/S 

L	100 cm / 39.37"
SP	50 cm / 19.68"
H	20 cm / 7.87"

STANDARD LIGHTING

12xE14x10 W MAX (NOT INCL.)

USA 12xE12x40 W MAX (NOT INCL.)

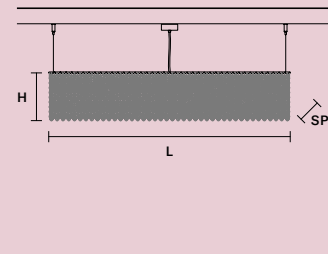

CUBO S/LONG/T 

L	100 cm / 39.37"
SP	50 cm / 19.67"
H	40 cm / 15.74"

STANDARD LIGHTING

18xE14x10 W MAX (NOT INCL.)

USA 18xE12x40 W MAX (NOT INCL.)

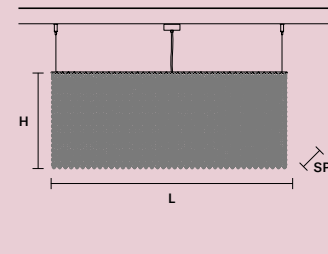

CUBO PL/SQUARE/SMALL 20 

L	12.5 cm / 4.92"
SP	12.5 cm / 4.92"
H	20 cm / 7.87"

STANDARD LIGHTING

1xE14x10 W MAX (NOT INCL.)

USA 1xE12x40 W MAX (NOT INCL.)

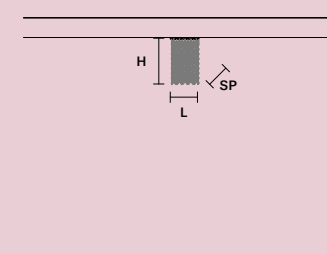

CUBO PL/SQUARE/SMALL 40 

L	12.5 cm / 4.92"
SP	12.5 cm / 4.92"
H	40 cm / 15.74"

STANDARD LIGHTING

1xE14x10 W MAX (NOT INCL.)

USA 1xE12x40 W MAX (NOT INCL.)

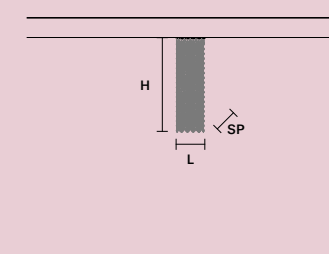

CUBO PL/SQUARE/SMALL 60 

L	12.5 cm / 4.92"
SP	12.5 cm / 4.92"
H	60 cm / 23.62"

STANDARD LIGHTING

3xE14x10 W MAX (NOT INCL.)

USA 3xE12x40 W MAX (NOT INCL.)

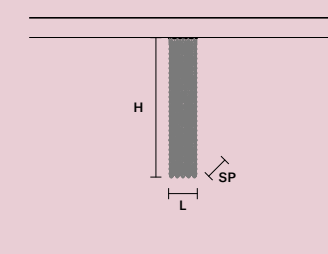

CUBO PL/SQUARE/SMALL 80 

L	12.5 cm / 4.92"
SP	12.5 cm / 4.92"
H	80 cm / 31.49"

STANDARD LIGHTING

3xE14x10 W MAX (NOT INCL.)

USA 3xE12x40 W MAX (NOT INCL.)

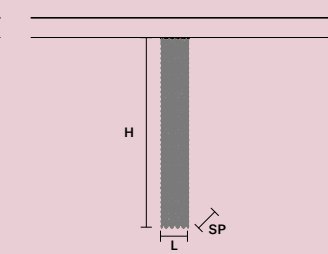

CUBO PL/SQUARE/MEDIUM 20 

L	25 cm / 9.84"
SP	25 cm / 9.84"
H	20 cm / 7.87"

STANDARD LIGHTING

4xE14x10 W MAX (NOT INCL.)

USA 4xE12x40 W MAX (NOT INCL.)

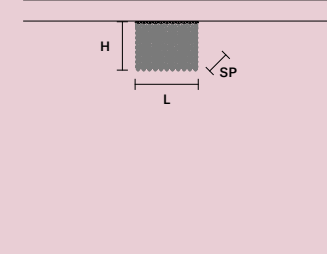

CUBO PL/SQUARE/MEDIUM 40 

L	25 cm / 9.84"
SP	25 cm / 9.84"
H	40 cm / 15.74"

STANDARD LIGHTING

7xE14x10 W MAX (NOT INCL.)

USA 7xE12x40 W MAX (NOT INCL.)

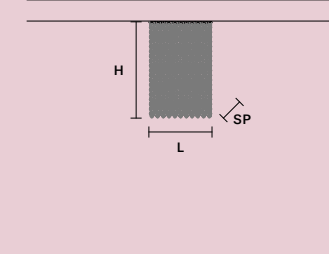

CUBO PL/SQUARE/MEDIUM 60 

L	25 cm / 9.84"
SP	25 cm / 9.84"
H	60 cm / 23.62"

STANDARD LIGHTING

8xE14x10 W MAX (NOT INCL.)

USA 8xE12x40 W MAX (NOT INCL.)

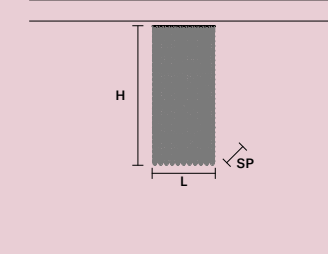

CUBO PL/SQUARE/MEDIUM 80 

L	25 cm / 9.84"
SP	25 cm / 9.84"
H	80 cm / 31.49"

STANDARD LIGHTING

10xE14x10 W MAX (NOT INCL.)

USA 10xE12x40 W MAX (NOT INCL.)

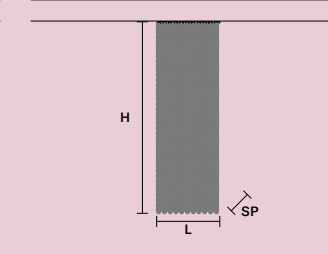

CUBO PL/SQUARE/LARGE 20 

L	50 cm / 19.68"
SP	50 cm / 19.68"
H	20 cm / 7.87"

STANDARD LIGHTING

12xE14x10 W MAX (NOT INCL.)

USA 12xE12x40 W MAX (NOT INCL.)

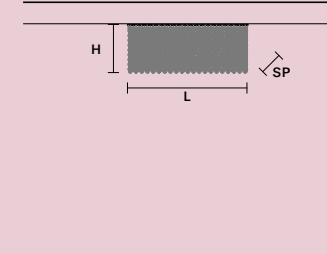

CUBO PL/SQUARE/LARGE 40 

L	50 cm / 19.68"
SP	50 cm / 19.68"
H	40 cm / 15.74"

STANDARD LIGHTING

12xE14x10 W MAX (NOT INCL.)

USA 12xE12x40 W MAX (NOT INCL.)

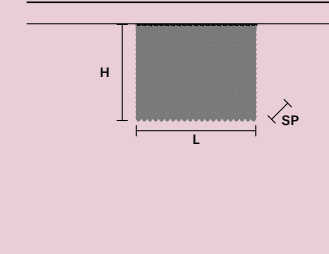

CUBO PL/LONG/A 

L	50 cm / 19.68"
SP	12.5 cm / 4.92"
H	20 cm / 7.87"

STANDARD LIGHTING

4xE14x10 W MAX (NOT INCL.)

USA 4xE12x40 W MAX (NOT INCL.)

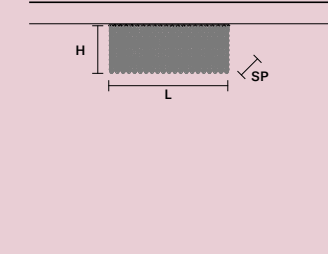

CUBO PL/LONG/B 

L	50 cm / 19.68"
SP	12.5 cm / 4.92"
H	40 cm / 15.74"

STANDARD LIGHTING

7xE14x10 W MAX (NOT INCL.)

USA 7xE12x40 W MAX (NOT INCL.)

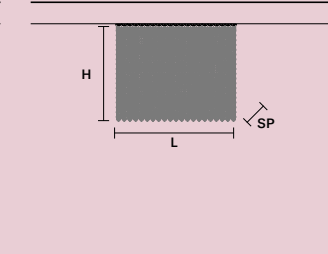

CUBO PL/LONG/C

L 50 cm / 19.68"
 SP 12.5 cm / 4.92"
 H 60 cm / 23.62"

STANDARD LIGHTING

7×E14×10 W MAX (NOT INCL.)

USA 7×E12×40 W MAX (NOT INCL.)

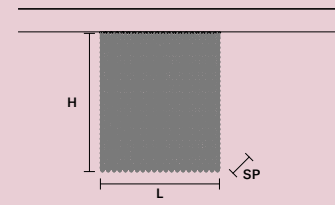
**CUBO PL/LONG/D**

L 75 cm / 29.52"
 SP 12.5 cm / 4.92"
 H 20 cm / 7.87"

STANDARD LIGHTING

5×E14×10 W MAX (NOT INCL.)

USA 5×E12×40 W MAX (NOT INCL.)

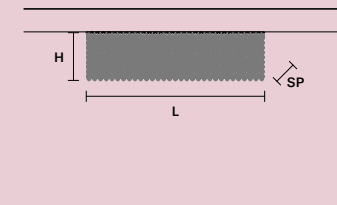
**CUBO PL/LONG/E**

L 75 cm / 29.52"
 SP 12.5 cm / 4.92"
 H 40 cm / 15.74"

STANDARD LIGHTING

9×E14×10 W MAX (NOT INCL.)

USA 9×E12×40 W MAX (NOT INCL.)

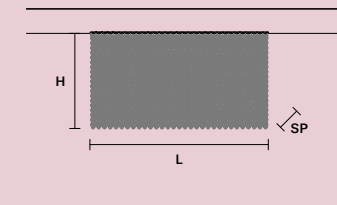
**CUBO PL/LONG/F**

L 75 cm / 29.52"
 SP 12.5 cm / 4.92"
 H 60 cm / 23.62"

STANDARD LIGHTING

9×E14×10 W MAX (NOT INCL.)

USA 9×E12×40 W MAX (NOT INCL.)

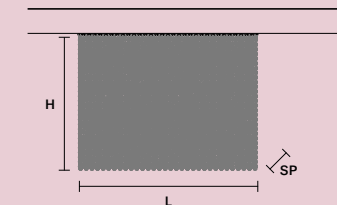
**CUBO PL/LONG/O**

L 75 cm / 29.52"
 SP 25 cm / 9.84"
 H 60 cm / 23.62"

STANDARD LIGHTING

17×E14×10 W MAX (NOT INCL.)

USA 17×E12×40 W MAX (NOT INCL.)

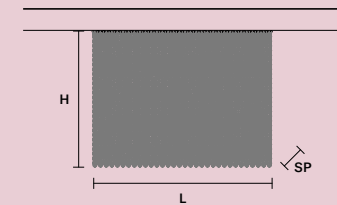
**CUBO PL/LONG/P**

L 100 cm / 39.37"
 SP 25 cm / 9.84"
 H 20 cm / 7.87"

STANDARD LIGHTING

12×E14×10 W MAX (NOT INCL.)

USA 12×E12×40 W MAX (NOT INCL.)

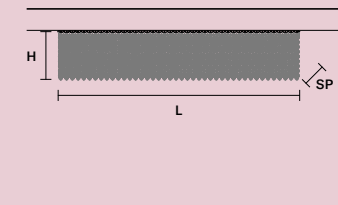
**CUBO PL/LONG/Q**

L 100 cm / 39.37"
 SP 25 cm / 9.84"
 H 40 cm / 15.74"

STANDARD LIGHTING

18×E14×10 W MAX (NOT INCL.)

USA 18×E12×40 W MAX (NOT INCL.)

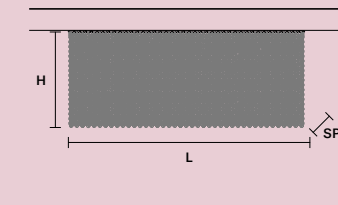
**CUBO PL/LONG/R**

L 100 cm / 39.37"
 SP 25 cm / 9.84"
 H 60 cm / 23.62"

STANDARD LIGHTING

18×E14×10 W MAX (NOT INCL.)

USA 18×E12×40 W MAX (NOT INCL.)

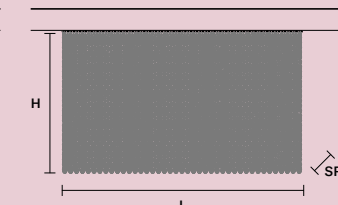
**CUBO PL/LONG/G**

L 100 cm / 39.37"
 SP 12.5 cm / 4.92"
 H 20 cm / 7.87"

STANDARD LIGHTING

6×E14×10 W MAX (NOT INCL.)

USA 6×E12×40 W MAX (NOT INCL.)

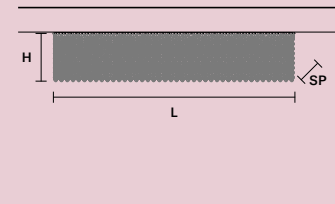
**CUBO PL/LONG/H**

L 100 cm / 39.37"
 SP 12.5 cm / 4.92"
 H 40 cm / 15.74"

STANDARD LIGHTING

11×E14×10 W MAX (NOT INCL.)

USA 11×E12×40 W MAX (NOT INCL.)

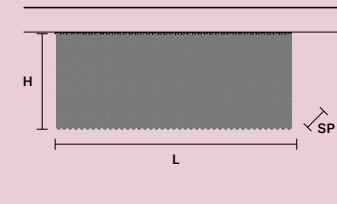
**CUBO PL/LONG/I**

L 100 cm / 39.37"
 SP 12.5 cm / 4.92"
 H 60 cm / 23.62"

STANDARD LIGHTING

11×E14×10 W MAX (NOT INCL.)

USA 11×E12×40 W MAX (NOT INCL.)

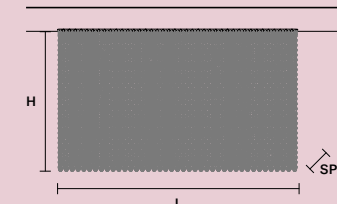
**CUBO PL/LONG/J**

L 50 cm / 19.68"
 SP 25 cm / 9.84"
 H 20 cm / 7.87"

STANDARD LIGHTING

8×E14×10 W MAX (NOT INCL.)

USA 8×E12×40 W MAX (NOT INCL.)

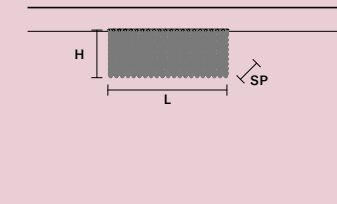
**CUBO PL/LONG/S**

L 100 cm / 39.37"
 SP 50 cm / 19.68"
 H 20 cm / 7.87"

STANDARD LIGHTING

12×E14×10 W MAX (NOT INCL.)

USA 12×E12×40 W MAX (NOT INCL.)

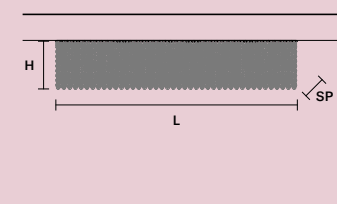
**CUBO PL/LONG/T**

L 100 cm / 39.37"
 SP 50 cm / 19.67"
 H 40 cm / 15.74"

STANDARD LIGHTING

18×E14×10 W MAX (NOT INCL.)

USA 18×E12×40 W MAX (NOT INCL.)

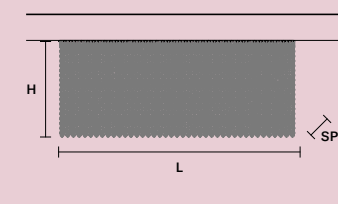
**CUBO A/SQUARE**

L 12.5 cm / 4.92"
 SP 12.5 cm / 4.92"
 H 25 cm / 9.84"

STANDARD LIGHTING

1×E14×10 W MAX (NOT INCL.)

USA 1×E12×40 W MAX (NOT INCL.)

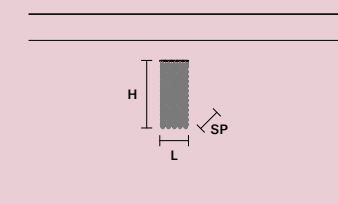
**CUBO A/LONG**

L 40 cm / 15.74"
 SP 12.5 cm / 4.92"
 H 20 cm / 7.87"

STANDARD LIGHTING

4×E14×10 W MAX (NOT INCL.)

USA 4×E12×40 W MAX (NOT INCL.)

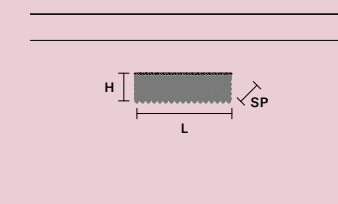
**CUBO PL/LONG/K**

L 50 cm / 19.68"
 SP 25 cm / 9.84"
 H 40 cm / 15.74"

STANDARD LIGHTING

12×E14×10 W MAX (NOT INCL.)

USA 12×E12×40 W MAX (NOT INCL.)

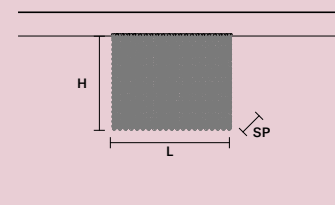
**CUBO PL/LONG/L**

L 50 cm / 19.68"
 SP 25 cm / 9.84"
 H 60 cm / 23.62"

STANDARD LIGHTING

12×E14×10 W MAX (NOT INCL.)

USA 12×E12×40 W MAX (NOT INCL.)

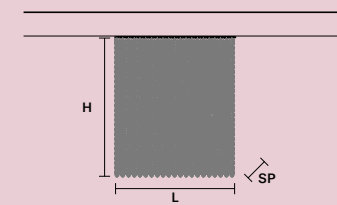
**CUBO PL/LONG/M**

L 75 cm / 29.52"
 SP 25 cm / 9.84"
 H 20 cm / 7.87"

STANDARD LIGHTING

9×E14×10 W MAX (NOT INCL.)

USA 9×E12×40 W MAX (NOT INCL.)

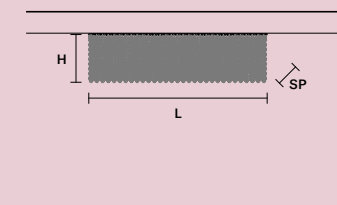
**CUBO PL/LONG/N**

L 75 cm / 29.52"
 SP 25 cm / 9.84"
 H 40 cm / 15.74"

STANDARD LIGHTING

17×E14×10 W MAX (NOT INCL.)

USA 17×E12×40 W MAX (NOT INCL.)

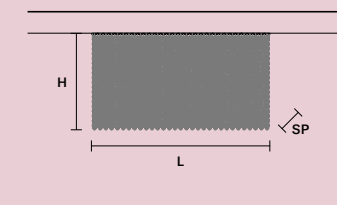

CUBO S/COMBO 100

L 100 cm / 39.37"
 SP 87,5 cm / 34,44"
 H 80 cm / 31.49"

STANDARD LIGHTING
 48×E14×10 W MAX (NOT INCL.)
 USA 48×E12×40 W MAX (NOT INCL.)

CUBO S/COMBO 150

L 75 cm / 29.52"
 SP 150 cm / 59.05"
 H 60 cm / 23.62"

STANDARD LIGHTING
 69×E14×10 W MAX (NOT INCL.)
 USA 69×E12×40 W MAX (NOT INCL.)

CUBO S/COMBO 175

L 175 cm / 68.89"
 SP 175 cm / 68.89"
 H 100 cm / 39.37"

STANDARD LIGHTING
 80×E14×10 W MAX (NOT INCL.)
 USA 80×E12×40 W MAX (NOT INCL.)

CUBO S/COMBO 300

L 100 cm / 39.37"
 SP 300 cm / 118.11"
 H 120 cm / 47.24"

STANDARD LIGHTING
 192×E14×10 W MAX (NOT INCL.)
 USA 192×E12×40 W MAX (NOT INCL.)

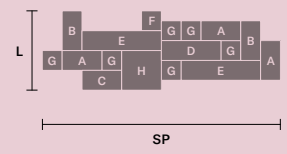
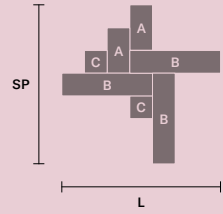
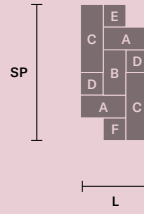
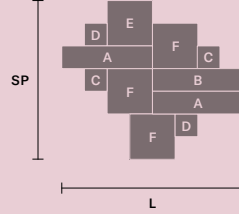
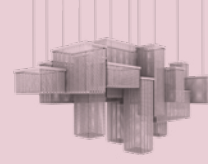
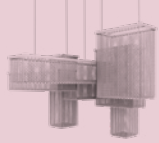
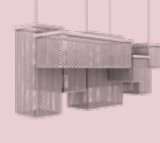
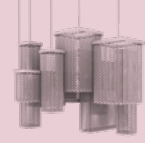

COMPONENTS

- A** 2×S/Long/A
- B** 1×S/Long/B
- C** 2×S/Square/Small 40
- D** 2×S/Square/Small 60
- E** 1×S/Square/Medium 20
- F** 3×S/Square/Medium 40

COMPONENTS

- A** 2×S/Long/J
- B** 1×S/Long/L
- C** 2×S/Long/M
- D** 2×S/Square/Medium 20
- E** 1×S/Square/Medium 40
- F** 1×S/Square/Medium 60

COMPONENTS

- A** 2×S/Long/L
- B** 3×S/Long/P
- C** 2×S/Square/Medium 80

COMPONENTS

- A** 3×S/Long/J
- B** 2×S/Long/K
- C** 1×S/Long/L
- D** 1×S/Long/O
- E** 2×S/Long/Q
- F** 1×Square/Medium 40
- G** 6×Square/Medium 80
- H** 1×Square/Large 40

CUBO PL/COMBO 100

L 100 cm / 39.37"
 SP 100 cm / 39.37"
 H 80 cm / 31.49"

STANDARD LIGHTING
 51×E14×10 W MAX (NOT INCL.)
 USA 51×E12×40 W MAX (NOT INCL.)

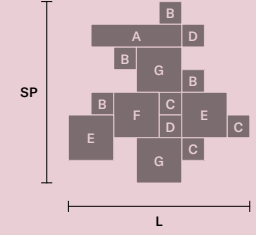
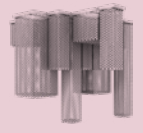

CUBO PL/COMBO 150

L 75 cm / 29.52"
 SP 150 cm / 59.05"
 H 60 cm / 23.62"

STANDARD LIGHTING
 53×E14×10 W MAX (NOT INCL.)
 USA 53×E12×40 W MAX (NOT INCL.)

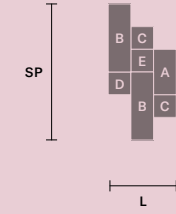
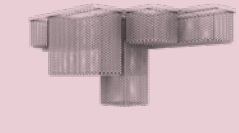

CUBO PL/COMBO 175

L 175 cm / 68.89"
 SP 175 cm / 68.89"
 H 80 cm / 31.49"

STANDARD LIGHTING
 107×E14×10 W MAX (NOT INCL.)
 USA 107×E12×40 W MAX (NOT INCL.)

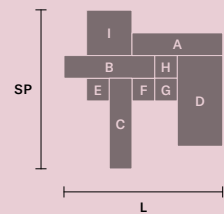
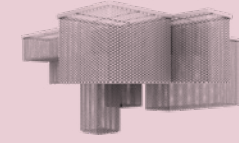

CUBO PL/COMBO 300

L 100 cm / 39.37"
 SP 300 cm / 118.11"
 H 80 cm / 31.49"

STANDARD LIGHTING
 195×E14×10 W MAX (NOT INCL.)
 USA 195×E12×40 W MAX (NOT INCL.)

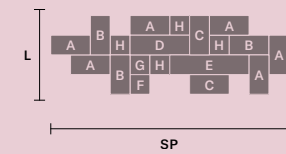
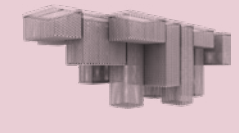

COMPONENTS

- A** 1×PL/Long/P
- B** 1×PL/Long/Q
- C** 1×PL/Long/R
- D** 1×PL/Long/T
- E** 1×PL/Square/Medium 20
- F** 1×PL/Square/Medium 40
- G** 1×PL/Square/Medium 60
- H** 1×PL/Square/Medium 80
- I** 1×PL/Square/Large 60

COMPONENTS

- A** 6×PL/Long/J
- B** 3×PL/Long/k
- C** 2×PL/Long/L
- D** 1×PL/Long/O
- E** 1×PL/Long/Q
- F** 1×PL/Square/Medium 20
- G** 1×PL/Square/Medium 60
- H** 4×PL/Square/Medium 80

Eva

IT L'abbiamo chiamata Eva, non a caso. La collezione Eva incarna magnificamente la trasposizione in chiave moderna dei lampadari classici. Come un fiore appena sbocciato ti incanta per la sua fluida sinuosità, trasmettendo un senso di pace e appagamento.

EN Not by chance we named it Eva. The Eva collection magnificently embodies the modern interpretation of classic chandeliers. Like a freshly opened flower, it enchants you with its fluid sinuosity, conveying a sense of peace and contentment.

DESIGN BY
MASIERO LAB

SUSPENSION
APPLIQUE
TABLE LAMP
FLOOR LAMP

EVA S10







EVA A2



EVA S3+1







EVA TL1 M



EVA STL3+1

Eva

Lampada con struttura in resina e poliuretano. Paralumi in alluminio. Lamp with resin and polyurethane frame. Aluminium lampshades.

Lampe mit Resin und Polyurethanstruktur. Lampenschirme aus Aluminium.

Lámpara con estructura de resina y poliuretano. Pantallas de aluminio.

Lampe avec structure en resin et polyurethane. Abat-jour en aluminium.

Лампа с каркасом из полиуретана. Алюминиевые абажуры.

这种灯具有一个树脂和聚氨酯的结构。灯罩们是铝材做的。

مصباح بهيكل من الراتنج والبولي يوريثان. عاكس ضوء (غطاء مصباح) من الألمنيوم.



F01 Foglia oro Gold leaf



F02 Foglia argento Silver leaf

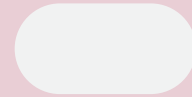

v95 Bianco opaco Matt white



v50 Blue navy

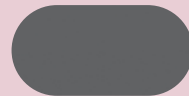

v72 Grigio scuro Dark grey

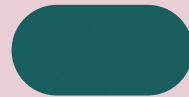

v60 Verde ottanio Ottanio green



v70 Cemento Concrete



v30 Rosso ossido Oxide red

EVA S20+10

ø 270 cm / 106.29"
H 200 cm / 78.74"

STANDARD LIGHTING
30×E27×20 W MAX (NOT INCL.)

USA 30×E26×60 W MAX (NOT INCL.)

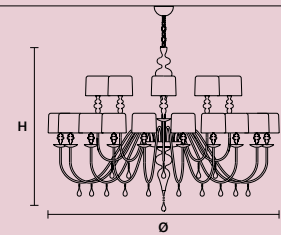

EVA S10

ø 110 cm / 43.30"
H 75 cm / 29.52"

STANDARD LIGHTING
10×E14×10 W MAX (NOT INCL.)

USA 10×E12×40 W MAX (NOT INCL.)

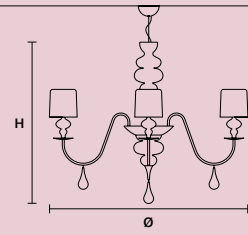

EVA S8

ø 90 cm / 35.43"
H 75 cm / 29.52"

STANDARD LIGHTING
8×E14×10 W MAX (NOT INCL.)

USA 8×E12×40 W MAX (NOT INCL.)

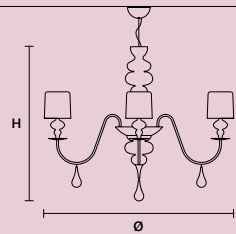

EVA S5

ø 70 cm / 27.56"
H 60 cm / 23.62"

STANDARD LIGHTING
5×E14×10 W MAX (NOT INCL.)

USA 5×E12×40 W MAX (NOT INCL.)

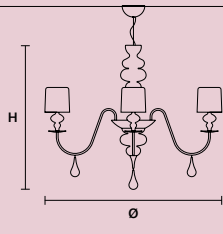

EVA S3+1

ø 50 cm / 19.68"
H 75 cm / 29.52"

STANDARD LIGHTING
3×E27×20 W MAX (NOT INCL.)
1×E14×10 W MAX (NOT INCL.)

USA 3×E26×60 W MAX (NOT INCL.)
1×E12×40 W MAX (NOT INCL.)

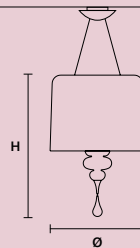

EVA A3

L 40 cm / 15.74"
SP 20 cm / 7.87"
H 70 cm / 27.56"

STANDARD LIGHTING
3×E27×20 W MAX (NOT INCL.)

USA 3×E26×60 W MAX (NOT INCL.)

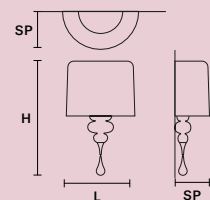

EVA A1 M

L 30 cm / 11.81"
SP 15 cm / 5.90"
H 54 cm / 21.25"

STANDARD LIGHTING
1×E27×20 W MAX (NOT INCL.)

USA 1×E26×60 W MAX (NOT INCL.)

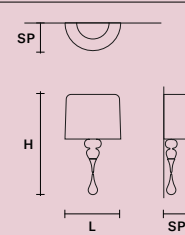

EVA A2

L 40 cm / 15.74"
SP 18 cm / 7.08"
H 55 cm / 21.65"

STANDARD LIGHTING
2×E14×10 W MAX (NOT INCL.)

USA 2×E12×40 W MAX (NOT INCL.)

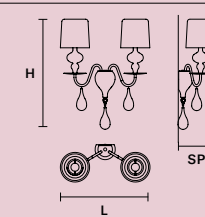

EVA TL1 P

ø 14 cm / 5.51"
H 28 cm / 11.02"

STANDARD LIGHTING
1×E14×10 W MAX (NOT INCL.)

USA 1×E12×40 W MAX (NOT INCL.)

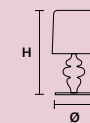

EVA TL1 M

ø 30 cm / 11.81"
H 53 cm / 20.86"

STANDARD LIGHTING
1×E27×20 W MAX (NOT INCL.)

USA 1×E26×60 W MAX (NOT INCL.)

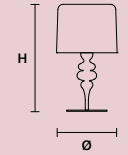

EVA TL3+1 G

ø 40 cm / 15.74"
H 75 cm / 29.52"

STANDARD LIGHTING
3×E27×20 W MAX (NOT INCL.)
1×E14×10 W MAX (NOT INCL.)

USA 3×E26×60 W MAX (NOT INCL.)
1×E12×40 W MAX (NOT INCL.)

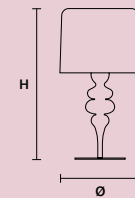

EVA STL3+1

ø 50 cm / 19.68"
H 180 cm / 70.86"

STANDARD LIGHTING
3×E27×20 W MAX (NOT INCL.)
1×E14×10 W MAX (NOT INCL.)

USA 3×E26×60 W MAX (NOT INCL.)
1×E12×40 W MAX (NOT INCL.)

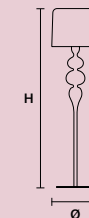

For the US market, refer to the relevant price list.

* ETL only for US market.

Sound

IT Che forma avrebbe il suono se fosse un prodotto? Sound ha un design che parla ai nostri sensi, illuminando la nostra mente e l'anima attraverso l'idea di un'armonica melodia progettuale. Il suono è un esperimento semantico formale. È una sinestesia. Sound è una combinazione di elementi circolari che evoca l'espansione delle onde sonore”.

EN What form would sound take if it were a product? The design of Sound speaks to our senses, illuminating our minds and souls through the idea of a harmonious melody of design. Sound is a formal semantic experiment. It is a synaesthesia. Sound is a combination of circular elements evoking the expansion of sound waves.

DESIGN BY
GIOVANNI BATTISTA
GIANOLA

SUSPENSION
CEILING
APPLIQUE
TABLE LAMP
FLOOR LAMP

SOUND OR6







SOUND S1



SOUND OR3





SOUND PL3

SOUND OR6





SOUND S6

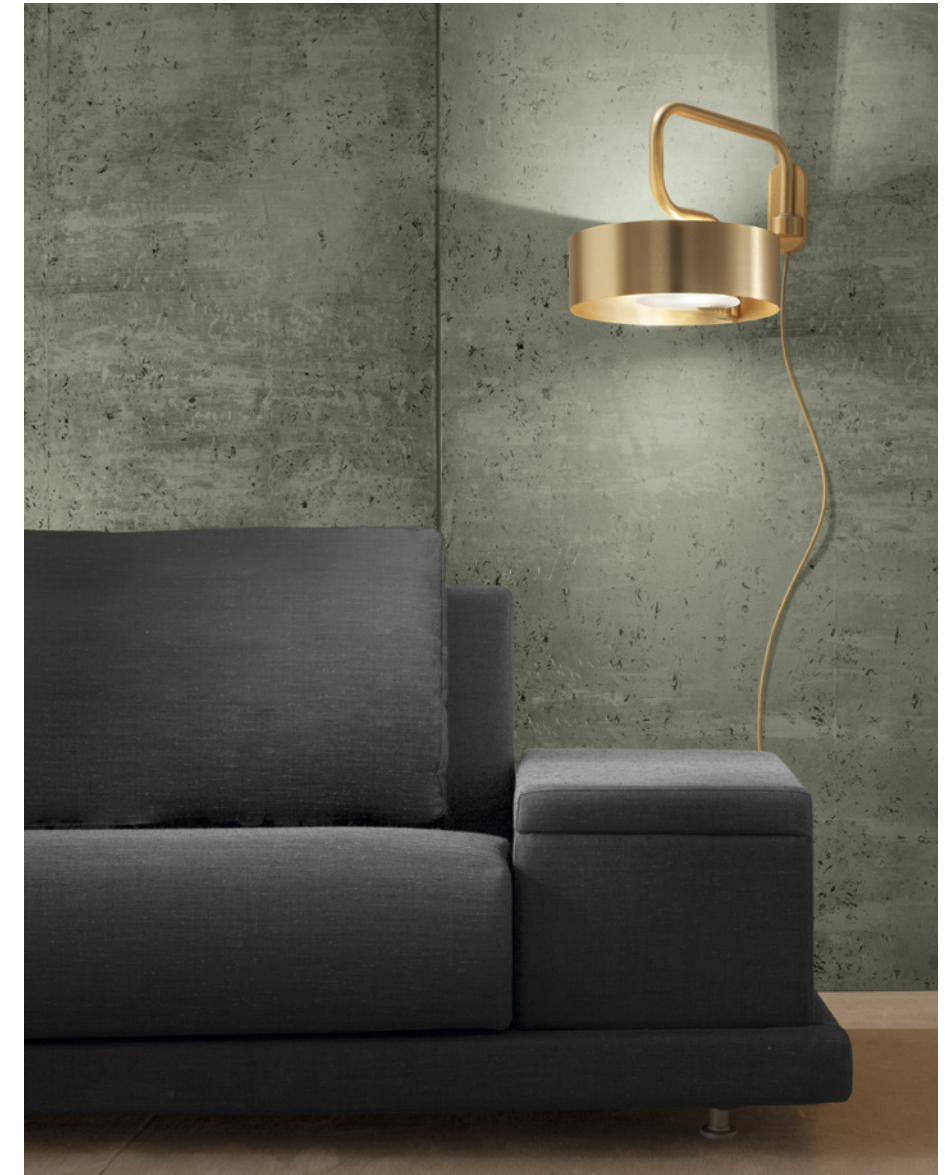

SOUND A1



Sound

Struttura in metallo, diffusore in vetro decorato.

Metal frame, decorated glass diffuser.

Metallstruktur, Diffusor aus dekoriertem Glas.

Estructura de metal, difusor de vidrio condecorado.

Structure en métal, diffuseur en verre coloré.

Металлический каркас, рассеиватель из декорированного стекла.

这种灯具有金属结构, 而且光扩散是装饰玻璃做的。







هيكل معدني،
ناشر ضوء زجاجي
مزخرف.









G12 Oro spazzolato
Brushed gold







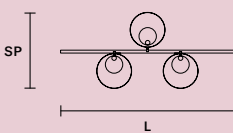
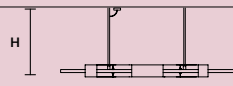

G18 Ottone spazzolato+Nero opaco
v90 Brushed brass+Matt black

SOUND S1	
ø	30 cm / 11.81"
H	60 cm / 23.62"
WITH ROD B**	
STANDARD LIGHTING  	
1xG9x10 W MAX (NOT INCL.)*	
INTEGRATED LED LIGHTING    	
UP	4,4 W CRI>90 3000 K – 650 NOMINAL LM
DOWN	4,4 W CRI>90 3000 K – 650 NOMINAL LM
DIMM	1-10V + PUSH







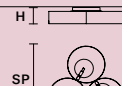

SOUND BIL3	
L	134 cm / 52.75"
SP	64 cm / 25.19"
H	58 cm / 22.83"
WITH ROD B**	
STANDARD LIGHTING  	
3xG9x10 W MAX (NOT INCL.)*	
INTEGRATED LED LIGHTING    	
UP	13,5 W CRI>90 3000 K – 1950 NOMINAL LM
DOWN	13,5 W CRI>90 3000 K – 1950 NOMINAL LM
DIMM	1-10V + PUSH







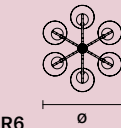
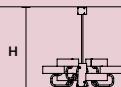

SOUND PL3	
L	60 cm / 23.62"
SP	56 cm / 22.04"
H	14 cm / 5.51"
STANDARD LIGHTING  	
3xG9x10 W MAX (NOT INCL.)*	
INTEGRATED LED LIGHTING    	
DOWN	13,5 W CRI>90 3000 K – 1950 NOMINAL LM
DIMM	1-10V + PUSH







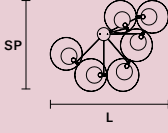
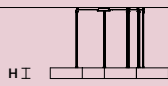

SOUND S6	
ø	110 cm / 43.30"
H	102 cm / 40.16"
WITH ROD B**	
STANDARD LIGHTING  	
6xG9x10 W MAX (NOT INCL.)*	
INTEGRATED LED LIGHTING    	
UP	26,5 W CRI>90 3000 K – 3900 NOMINAL LM
DOWN	26,5 W CRI>90 3000 K – 3900 NOMINAL LM
DIMM	1-10V + DALI + PUSH







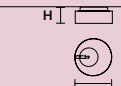

SOUND OR6	
L	120 cm / 47.24"
SP	80 cm / 31.49"
H	11 cm / 4.33"
STANDARD LIGHTING  	
6xG9x10 W MAX (NOT INCL.)*	
INTEGRATED LED LIGHTING    	
UP	26,5 W CRI>90 3000 K – 3900 NOMINAL LM
DOWN	26,5 W CRI>90 3000 K – 3900 NOMINAL LM
DIMM	1-10V + DALI + PUSH







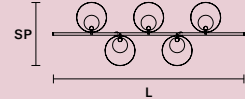
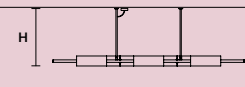

SOUND PL1	
ø	30 cm / 11.81"
H	13 cm / 5.11"
STANDARD LIGHTING  	
1xG9x10 W MAX (NOT INCL.)*	
INTEGRATED LED LIGHTING    	
DOWN	5,5 W CRI>90 3000 K – 873 NOMINAL LM
DIMM	1-10V + PUSH







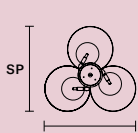
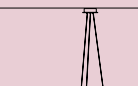

SOUND BIL5	
L	191 cm / 75.19"
SP	64 cm / 25.19"
H	58 cm / 22.83"
WITH ROD B**	
STANDARD LIGHTING  	
5xG9x10 W MAX (NOT INCL.)*	
INTEGRATED LED LIGHTING    	
UP	22 W CRI>90 3000 K – 3250 NOMINAL LM
DOWN	22 W CRI>90 3000 K – 3250 NOMINAL LM
DIMM	1-10V + DALI + PUSH







SOUND OR3	
L	60 cm / 23.62"
SP	56 cm / 22.04"
H	11 cm / 4.33"
STANDARD LIGHTING  	
3xG9x10 W MAX (NOT INCL.)*	
INTEGRATED LED LIGHTING    	
UP	13,5 W CRI>90 3000 K – 1950 NOMINAL LM
DOWN	13,5 W CRI>90 3000 K – 1950 NOMINAL LM
DIMM	1-10V + PUSH

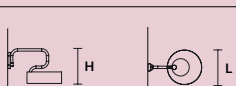





SOUND A1	
L	30 cm / 11.81"
SP	45 cm / 17.72"
H	30 cm / 11.81"
STANDARD LIGHTING  	
1xG9x10 W MAX (NOT INCL.)*	
INTEGRATED LED LIGHTING    	
UP	4,4 W CRI>90 3000 K – 650 NOMINAL LM
DOWN	4,4 W CRI>90 3000 K – 650 NOMINAL LM
DIMM	1-10V + PUSH

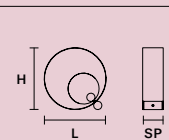

SOUND TL1	
L	30 cm / 11.81"
SP	11 cm / 4.33"
H	30 cm / 11.81"
STANDARD LIGHTING  	
1xG9x10 W MAX (NOT INCL.)*	
INTEGRATED LED LIGHTING   	
8,8 W CRI>90 3000 K – 1300 NOMINAL LM	
DIMM OWN BUTTON	



SOUND STL5	
L	46 cm / 18.11"
SP	10 cm / 3.93"
H	225 cm / 88.58"
STANDARD LIGHTING  	
5xG9x10 W MAX (NOT INCL.)*	
INTEGRATED LED LIGHTING   	
44 W CRI>90 3000 K – 6500 NOMINAL LM	
DIMM OWN BUTTON	

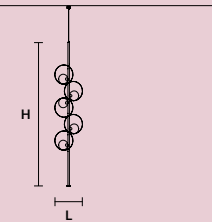

Accessories

** It is possible to choose a specific height for fixed rod of items Sound S1, Sound S6, Sound BIL5, Sound BIL3. When not specified in the order confirmation, the standard height for the rod is "B". É possibile scegliere un'altezza specifica per le aste rigide degli articoli Sound S1, Sound S6, Sound BIL5, Sound BIL3. Se non specificato in fase d'ordine, l'altezza dell'asta rigida standard è "B".

SOUND ROD S1**	
H	A: 11 cm / 4.33" B: 31 cm / 12.20" C: 51 cm / 20.08"

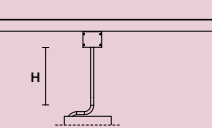

SOUND ROD S6**	
H	A: 30 cm / 11.81" B: 50 cm / 19.68" C: 70 cm / 27.55"

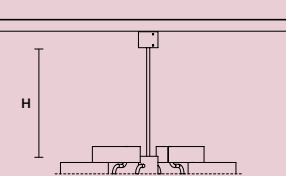

SOUND ROD BIL5** - BIL3**	
H	A: 30 cm / 11.81" B: 50 cm / 19.68" C: 70 cm / 27.55"

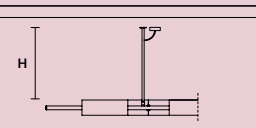

FLOOR LAMP BASE	
H	1 cm / 0.39"
ø	40 cm / 15.74"

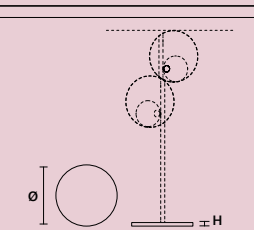

 For the US market, refer to the relevant price list.

* ETL only for US market.
*G9 bulbs also valid for USA market.

Timeo

IT È il gioco delle geometrie e la regolarità delle forme che caratterizzano questa collezione di lampade. Timeo prende il nome dal dialogo di Platone, Timeo, il testo base della cosmogonia in cui si delinea il concetto di solidi platonici.

EN This collection of lamps stands out for the interplay of geometries and regularity of the shapes. It takes its name from Plato's dialogue, the Timaeus, the basic text of cosmogony outlining the concept of Platonic solids.

TIMEO C3 LN 75

DESIGN BY
OMRI REVESZ

SUSPENSION
APPLIQUE
TABLE LAMP
FLOOR LAMP





TIMEO TL



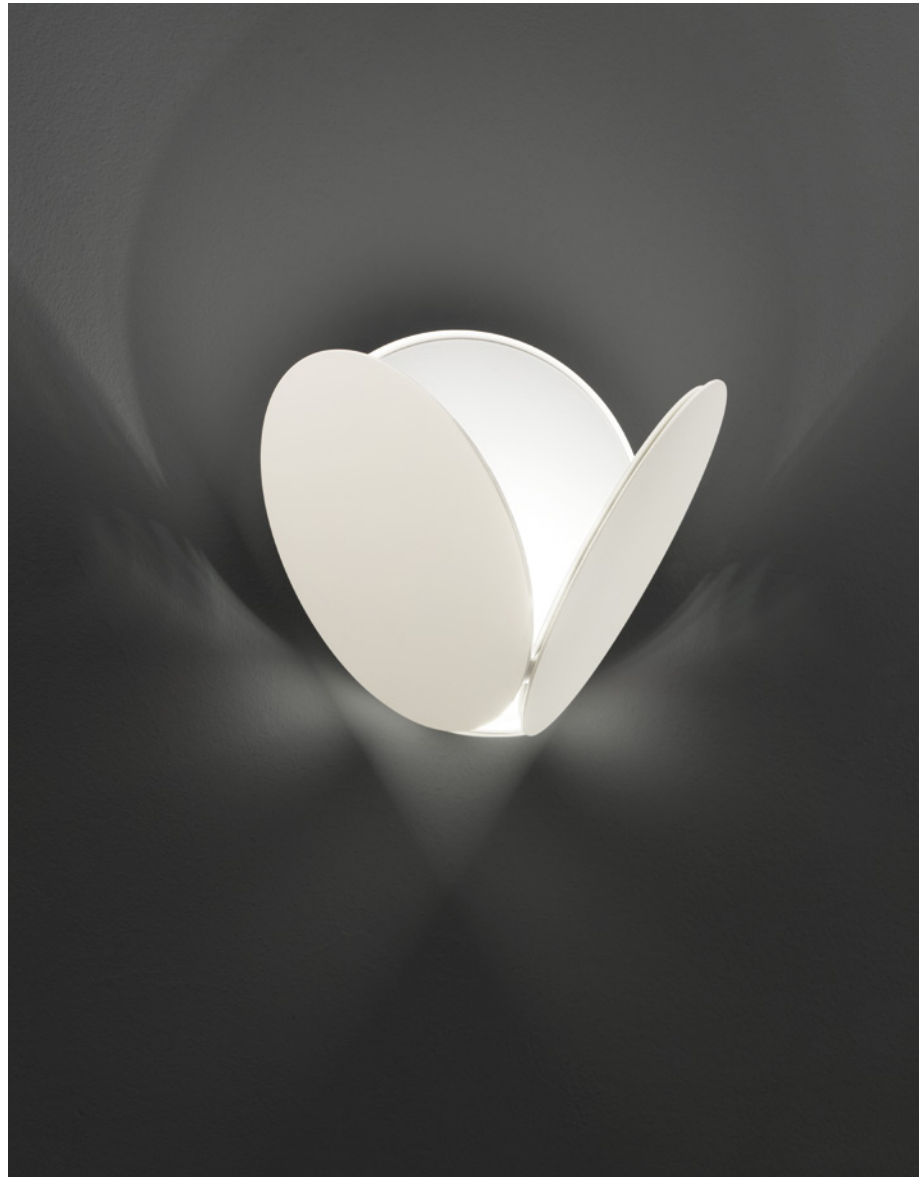

TIMEO A



Timeo

Struttura in metallo verniciato.
Illuminazione LED.

Painted metal frame. LED Lighting.

Gestell aus lackiertem Metall.
LED-Beleuchtung.

Estructura de metal pintado.
Iluminación LED.

Structure en métal peint.
LED éclairage.

Структура из окрашенного
металла. Светодиодное
освещение.

这种灯具的结构是涂漆的金属。LED
照明。

هيكل معدني مطلي.
إضاءة LED.



G14 Ottone brunito
Burnished brass

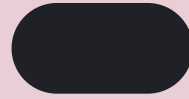

V91 Nero gofrato
Embossed black

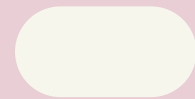

V98 Bianco gofrato
Embossed white

TIMEO S1 20		CE	UL
ø	21 cm / 8.26"		
H	17 cm / 6.69"		
INTEGRATED LED LIGHTING			
LED	4 W CRI>90 3000 K - 460 NOMINAL LM		
DIMM	NO		

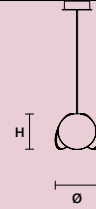

TIMEO A		CE	UL
L	21 cm / 8.26"		
SP	19 cm / 7.48"		
H	20 cm / 7.87"		
INTEGRATED LED LIGHTING			
LED	4 W CRI>90 3000 K - 460 NOMINAL LM		
DIMM	NO		

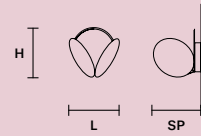

TIMEO C3 LN 75		CE	UL
L	75 cm / 29.52"		
SP	20 cm / 7.87"		
H MAX	140 cm / 55.11"		
INTEGRATED LED LIGHTING			
LED	12 W CRI>90 3000 K - 1350 NOMINAL LM		
DIMM	1-10V + PUSH		

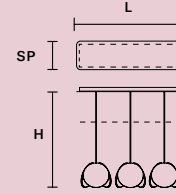

TIMEO C5 LN 125		CE	UL
L	125 cm / 49.21"		
SP	20 cm / 7.87"		
H MAX	140 cm / 55.11"		
INTEGRATED LED LIGHTING			
LED	20 W CRI>90 3000 K - 2300 NOMINAL LM		
DIMM	1-10V + DALI + PUSH		

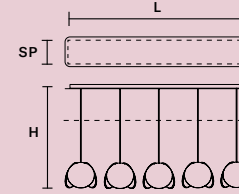

TIMEO C7 LN 175		CE	UL
L	175 cm / 68.89"		
SP	20 cm / 7.87"		
H MAX	140 cm / 55.11"		
INTEGRATED LED LIGHTING			
LED	28 W CRI>90 3000 K - 3150 NOMINAL LM		
DIMM	1-10V + DALI + PUSH		

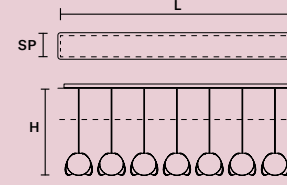

TIMEO STL		CE	UL
ø	35 cm / 11.81"		
H	160 cm / 62.99"		
INTEGRATED LED LIGHTING			
LED	9 W CRI>90 3000 K - 1458 NOMINAL LM		
DIMM	OWN BUTTON		

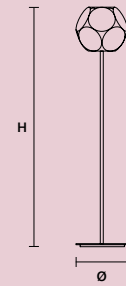

TIMEO TL		CE	UL
ø	35 cm / 13.77"		
H	30 cm / 11.81"		
INTEGRATED LED LIGHTING			
LED	9 W CRI>90 3000 K - 1458 NOMINAL LM		
DIMM	OWN BUTTON		

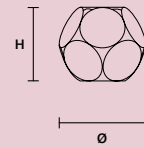

TIMEO C3 RD 40		CE	UL
ø	40 cm / 15.74"		
H MAX	140 cm / 55.11"		
INTEGRATED LED LIGHTING			
LED	12 W CRI>90 3000 K - 1350 NOMINAL LM		
DIMM	1-10V + PUSH		

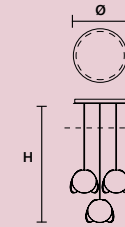

TIMEO C5 RD 60		CE	UL
ø	60 cm / 23.62"		
H MAX	140 cm / 55.11"		
INTEGRATED LED LIGHTING			
LED	20 W CRI>90 3000 K - 2300 NOMINAL LM		
DIMM	1-10V + DALI + PUSH		

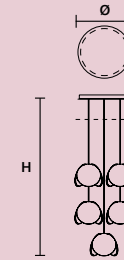

TIMEO C7 RD 80		CE	UL
ø	80 cm / 31.49"		
H MAX	140 cm / 55.11"		
INTEGRATED LED LIGHTING			
LED	28 W CRI>90 3000 K - 3150 NOMINAL LM		
DIMM	1-10V + DALI + PUSH		

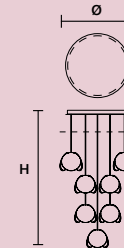

UL For the US market, refer to
the relevant price list.

Libe

IT Un disegno perfetto, dove le forme geometriche semplici e lineari si concretizzano in un oggetto. Come magia un tratto di matita diventa realtà per mezzo di sapienti mani e pregiati materiali, come il legno, l'ottone e le losanghe di cristallo.

EN A perfect design, where simple, linear geometric shapes take concrete form in an object. As if by magic, a pencil stroke becomes reality, thanks to skilful hands and precious materials such as wood, brass and crystal lozenges.

LIBE COMBO 140



DESIGN BY
GIAMPAOLO RAMPOLLA
E ANDREA LIGUORI

SUSPENSION
APPLIQUE
TABLE LAMP

LIBE ROUND TL 40



LIBE A55





LIBE S160



LIBE ELLIPSE S120

Libe

Struttura in metallo o in legno con diffusore in losanghe di cristallo opaco. Illuminazione a LED.

Metal or wood frame with diffuser in opaque crystal lozenges. LED lighting.

Gestell aus Metall oder Holz mit Diffusor aus matten Kristallrauten. LED-Beleuchtung.

Estructura de metal o de madera con difusor en pastillas de cristal opaco. Iluminación LED.

Structure en métal ou en bois avec diffuseur en losanges de cristal opaque. Éclairage à LED.

Металлический или деревянный каркас с рассеивателем в виде ромбов из матового хрустала. Светодиодное освещение.

这种 灯具具有金属或木制的结构，然而光扩散是不透明的水晶们。LED照明。

هيكل من المعدن أو الخشب مع ناشر ضوء في هيئة معين من الكريستال غير اللامع. إضاءة ليد.



w01 Rovere



w03 Wengé



G14 Ottone brunito
Burnished brass

LIBE S160	
L	160 cm / 62.99"
SP	16 cm / 6.29"
H	30 cm / 11.81"
INTEGRATED LED LIGHTING	
104 W CRI>90 3000 K – 9770 NOMINAL LM	
DIMM	1-10V

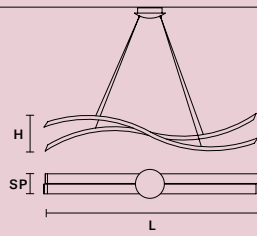

LIBE S100	
L	100 cm / 39.37"
SP	16 cm / 6.29"
H	20 cm / 7.87"
INTEGRATED LED LIGHTING	
63 W CRI>90 3000 K – 5922 NOMINAL LM	
DIMM	0-10V

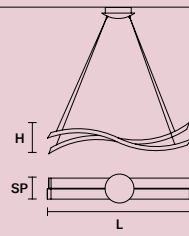

LIBE ROUND S140	
ø	140 cm / 55.11"
H	8,5 cm / 3.34"
INTEGRATED LED LIGHTING	
144 W CRI>90 3000 K – 13536 NOMINAL LM	
DIMM	1-10V

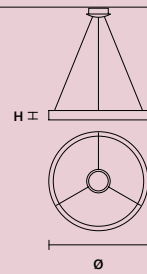

LIBE ROUND TL40	
L	40 cm / 15.74"
SP	30 cm / 11.81"
H	43 cm / 16.93"
INTEGRATED LED LIGHTING	
36,5 W CRI>90 3000 K – 3431 NOMINAL LM	
DIMM	OWN BUTTON

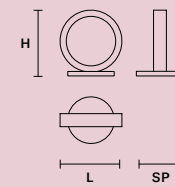

LIBE ROUND S115	
ø	115 cm / 45.27"
H	8,5 cm / 3.34"
INTEGRATED LED LIGHTING	
116 W CRI>90 3000 K – 10904 NOMINAL LM	
DIMM	1-10V

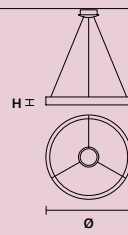

LIBE ROUND S90	
ø	90 cm / 35.43"
H	8,5 cm / 3.34"
INTEGRATED LED LIGHTING	
90 W CRI>90 3000 K – 8460 NOMINAL LM	
DIMM	0-10V

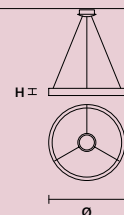

LIBE ROUND S60	
ø	60 cm / 23.62"
H	8,5 cm / 3.34"
INTEGRATED LED LIGHTING	
59 W CRI>90 3000 K – 5546 NOMINAL LM	
DIMM	0-10V

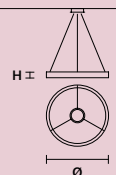

LIBE ELLIPSE S120	
L	120 cm / 47.24"
SP	40 cm / 15.74"
H	8,5 cm / 3.34"
INTEGRATED LED LIGHTING	
86,5 W CRI>90 3000 K – 8131 NOMINAL LM	
DIMM	0-10V

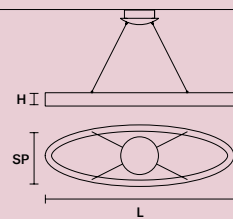

LIBE ELLIPSE S90	
L	90 cm / 35.43"
SP	30 cm / 11.81"
H	8,5 cm / 3.34"
INTEGRATED LED LIGHTING	
62,5 W CRI>90 3000 K – 5875 NOMINAL LM	
DIMM	0-10V

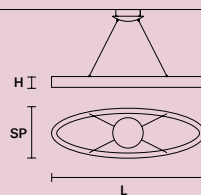

LIBE A55	
L	55 cm / 21.65"
SP	8 cm / 3.14"
H	8,5 cm / 3.34"
INTEGRATED LED LIGHTING	
7 W CRI>90 3000 K – 658 NOMINAL LM	
DIMM	NO

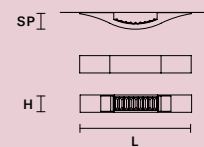

For the US market, refer to the relevant price list.

Palm

IT La applique Palm è un sistema modulare da parete che ricorda il movimento leggiadro delle foglie. Perfette per la decorazione murale grazie alla loro componibilità, Palm trae ispirazione dalla natura. Un progetto pensato per essere composto come un puzzle grazie alle forme che si incastrano.

EN The Palm applique is a modular wall system reminiscent of the graceful movement of leaves. Inspired by nature, Palm's modularity makes it perfect as a wall decoration. Made up of interlocking shapes, the project is conceived to be composed like a jigsaw puzzle.

DESIGN BY
LETIZIA MAMMINI
E VALERIA CANDIDO

APPLIQUE

PALM A21
COMPOSITION





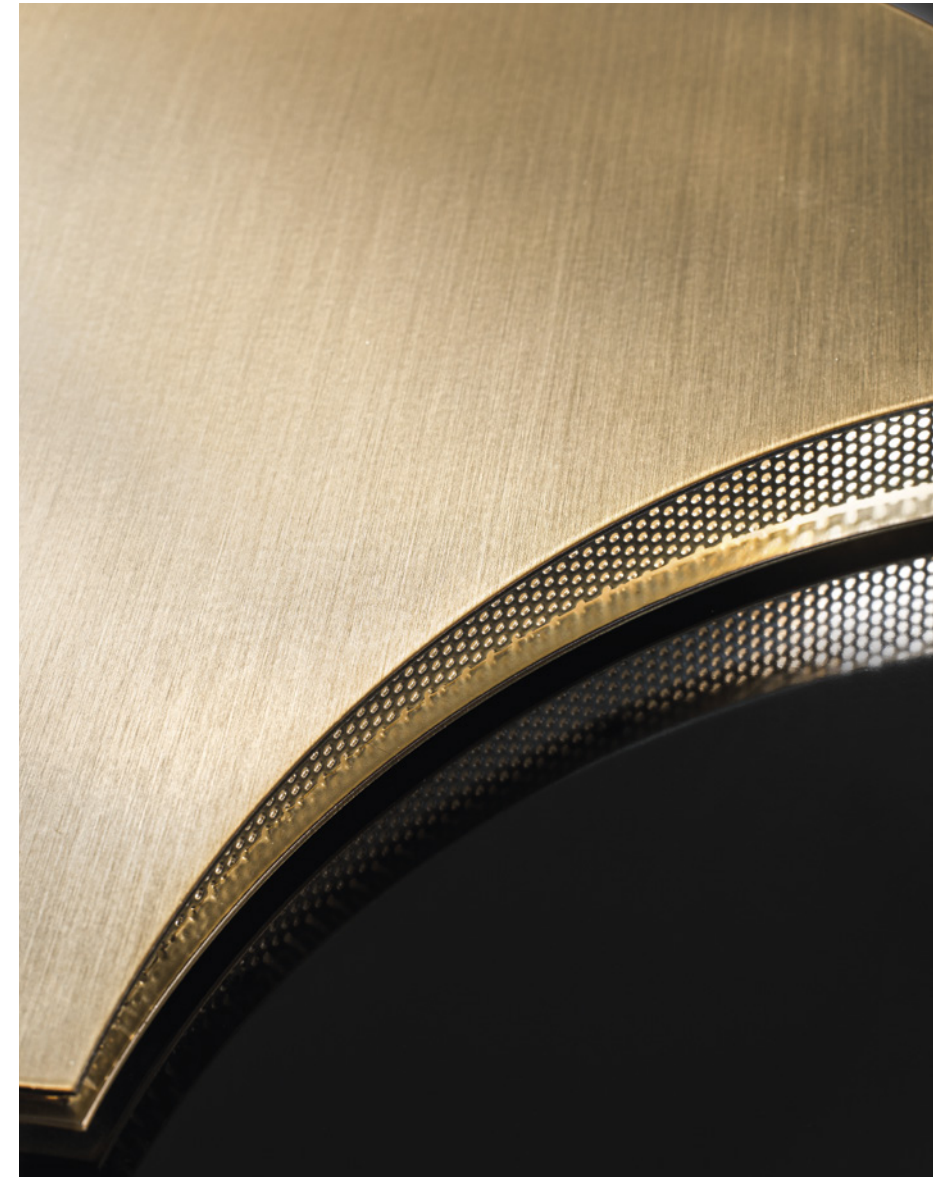

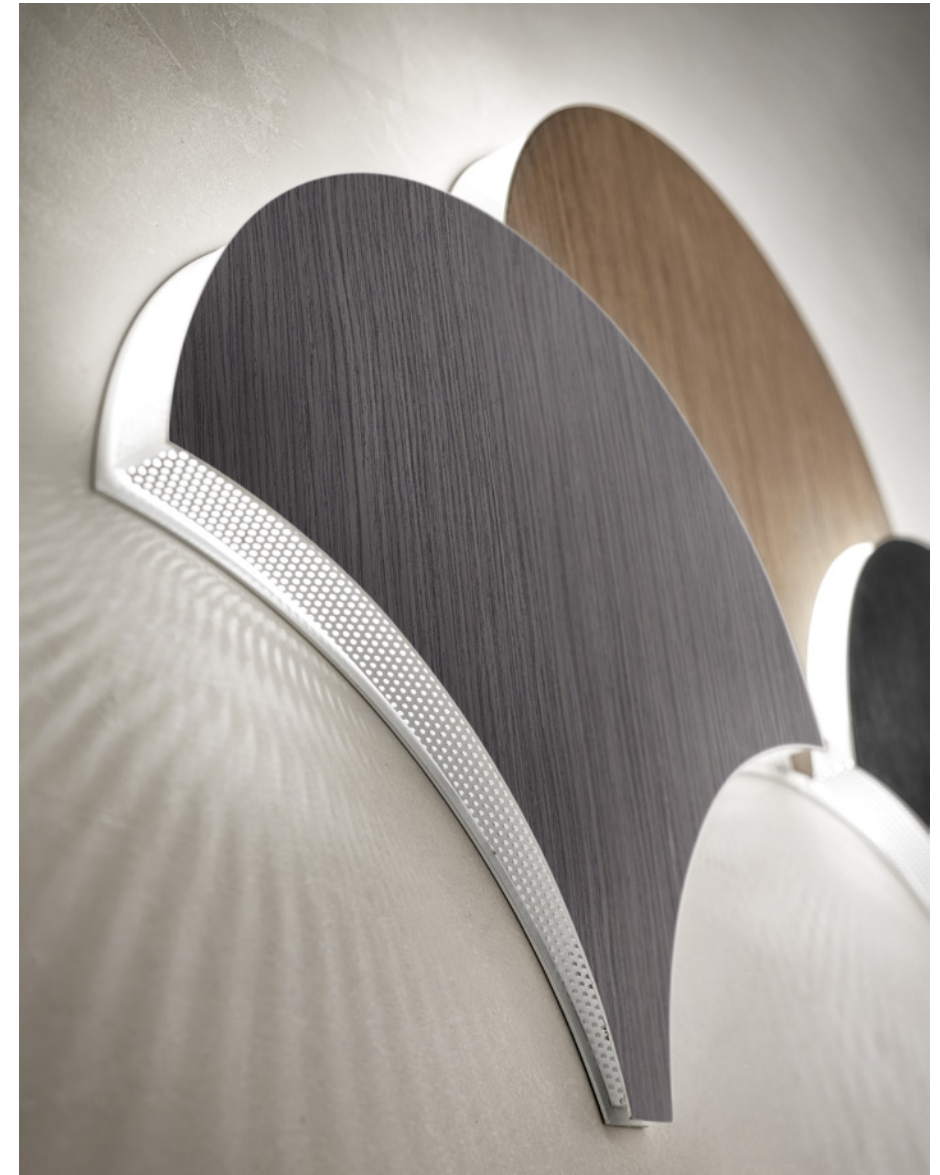

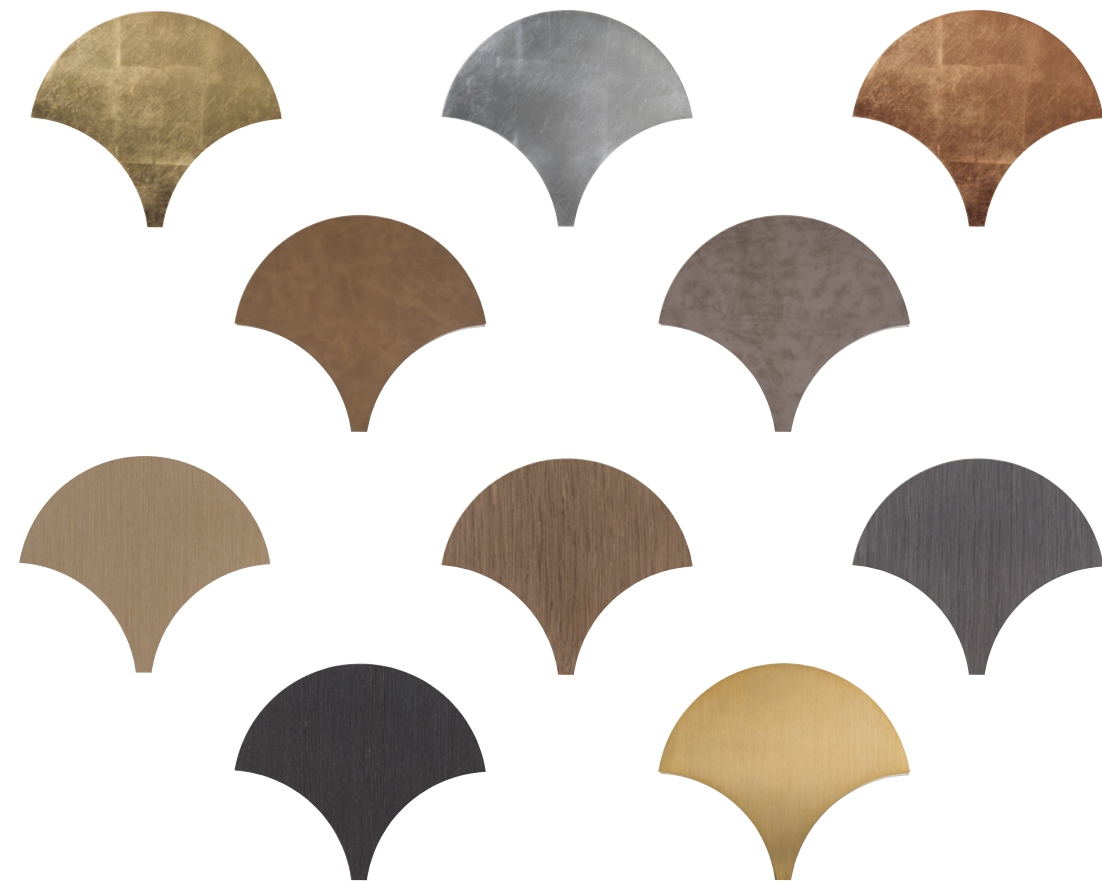

PALM F01

PALM F02

PALM F03

PALM L02

PALM L03

PALM W04

PALM W05

PALM W06

PALM W07

PALM G14

PALM A40 COMPOSITION



Palm

Struttura in metallo verniciato, rivestimento in diverse finiture. Illuminazione a LED.

Painted metal frame, different finishes cover. LED lighting.

Struktur aus lackiertem Metall, in verschiedenen Ausführungen erhältlich. LED-Leuchtsystem.

Estructura de metal pintado, revestimiento en diferentes acabados. Iluminación LED.

Structure en metal verni, différentes finitions disponibles, éclairage LED.

Окрашенный металлический каркас, подвесы с различной отделкой, светодиодное освещение.

这种灯具的结构是涂漆的金属, 而且在框架上可能选择不同的材料类型。 LED 照明。

هيكل معدني مطلي،
مغطى بلمسات نهائية متنوعة.
إضاءة ليد.

PALM A40		CCC	RoHS	CE
L	40 cm / 15.75"			
SP	5 cm / 1.97"			
H	34 cm / 13.39"			
INTEGRATED LED LIGHTING				
LED	11 W CRI>95 3000 K - 1390 NOMINAL LM			
DIMM	NO			

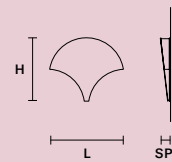

PALM A21		CCC	RoHS	CE
L	21 cm / 8.26"			
SP	4 cm / 1.57"			
H	18 cm / 7.08"			
INTEGRATED LED LIGHTING				
LED	5 W CRI>95 3000 K - 772 NOMINAL LM			
DIMM	NO			

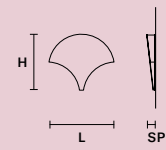

f01 Foglia oro
Gold leaf



f02 Foglia argento
Silver leaf



f03 Foglia rame
Copper leaf



g14 Ottone brunito
Burnished brass



l03 Pelle 3
Leather 3



w04 Pale oak



w05 Walnut



w06 Grey ayous



w07 Black&Silver



l02 Pelle 2
Leather 2

 For the US market, refer to the relevant price list.

Skyline

IT Niente contraddistingue New York più del suo famoso Skyline: il profilo dei grattacieli di Manhattan è la rappresentazione iconografica più calzante di una metropoli unica al mondo. Skyline è la collezione di Masiero che rende omaggio a questo simbolo di modernità e design.

EN Nothing distinguishes New York City more than its famous skyline. The outline of Manhattan's skyscrapers is the most fitting iconographic representation of a metropolis unique in the world. The Masiero Skyline collection pays homage to this symbol of modernity and design.

SKYLINE S12

DESIGN BY
MASIERO LAB

SUSPENSION
APPLIQUE





SKYLINE A4



SKYLINE A2

Skyline

Struttura in metallo con pendagli in cristallo.

Painted metal frame with crystal pendants.

Gestell aus Metall mit Behang aus Kristall.

Estructura de metal con colgantes en cristal.

Structure en métal avec pampilles en cristal.

Металлический каркас с подвесками из хрусталя.

这种灯具有金属结构，而且它有水晶吊坠们。

هيكل معدني مع دلايات من الكريستال.

SKYLINE S20

L	133 cm / 52.36"
SP	50 cm / 19.68"
H	48 cm / 18.89"

STANDARD LIGHTING

20×E14×10 W MAX (NOT INCL.)

USA 20×E12×40 W MAX (NOT INCL.)

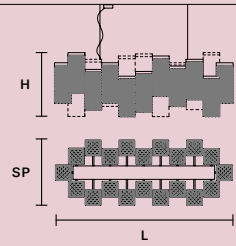

SKYLINE S12

L	83 cm / 32.67"
SP	50 cm / 19.68"
H	48 cm / 18.89"

STANDARD LIGHTING

12×E14×10 W MAX (NOT INCL.)

USA 12×E12×40 W MAX (NOT INCL.)

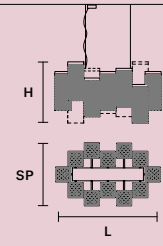

SKYLINE A2

L	25 cm / 9.84"
SP	23 cm / 9.05"
H	35 cm / 13.77"

STANDARD LIGHTING

2×E14×10 W MAX (NOT INCL.)

USA 2×E12×40 W MAX (NOT INCL.)

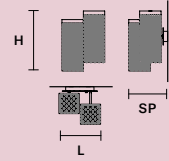

SKYLINE A4

L	50 cm / 19.68"
SP	23 cm / 9.05"
H	40 cm / 15.74"

STANDARD LIGHTING

4×E14×10 W MAX (NOT INCL.)

USA 4×E12×40 W MAX (NOT INCL.)

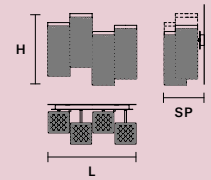

G14 Ottone brunito
Burnished brass



Pendagli in cristallo
Golden Fumé
Golden Smoky
crystal pendants

For the US market, refer to the relevant price list.

Vollee

IT Hai mai sognato di partire senza una meta? Volare in luoghi sconosciuti, in qualche modo? Vollee è una collezione ispirata alla leggerezza e intangibilità della luce. Le vele di metallo aleggiano nella stanza come paracadute liberi nel cielo.

EN Have you ever dreamed of setting out without a destination? To somehow fly to unknown places? The Vollee collection is inspired by the lightness and intangibility of light. The metal sails hover in the room like free parachutes in the sky.

VOLLEE S1 P UP
VOLLEE S1 P DOWN

DESIGN BY
LORENZ + KAZ

SUSPENSION



VOLLEE C5 P



VOLLEE C4 G



VOLLEE C5 P
COMPOSITION



VOLLEE C4P LN 125
COMPOSITION



Vollee

Struttura in metallo verniciato.
Illuminazione a LED.

Painted metal frame. LED Lighting.

Gestell aus lackiertem Metall.
LED-Beleuchtung.

Estructura de metal Pintado.
Iluminación LED.

Structure en métal peint. LED
éclairage.

Структура из окрашенного
металла. Светодиодное
освещение.

这种灯具的结构是涂漆的金属。LED
照明。

هيكل معدني مطلي.
إضاءة LED.

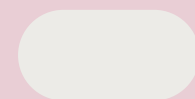

v95 Bianco opaco
Matt white



v55 Carta da zucchero
Mid Blue



v24 Zucca
Pumpkin

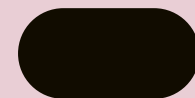

v90 Nero opaco
Matt black



v99 Oro opaco verniciato
Painted matt gold

VOLLEE S1G

L 52 cm / 20.47"
SP 36 cm / 14.17"
H 88 cm / 34.65"

INTEGRATED LED LIGHTING

7,5 W CRI>90
3000 K – 915 NOMINAL LM

DIMM NO

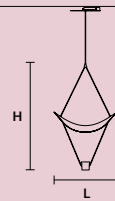

VOLLEE S1P DOWN

L 25 cm / 9.84"
SP 17,5 cm / 6.89"
H 44 cm / 17.32"

INTEGRATED LED LIGHTING

6,6 W CRI>90
3000 K – 825 NOMINAL LM

DIMM NO

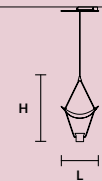

VOLLEE S1P UP

L 25 cm / 9.84"
SP 17,5 cm / 6.89"
H 44 cm / 17.32"

INTEGRATED LED LIGHTING

6,6 W CRI>90
3000 K – 825 NOMINAL LM

DIMM NO

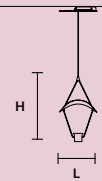

VOLLEE C4G RD 60

ø 96 cm / 37.80"
H 240 cm / 94.48"

INTEGRATED LED LIGHTING

25,6 W CRI>90
3000 K – 3200 NOMINAL LM

DIMM 1-10V + PUSH

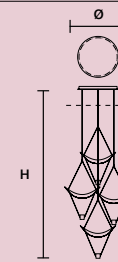

VOLLEE C4P RD 60

ø 60 cm / 37.80"
H 200 cm / 78.74"

INTEGRATED LED LIGHTING

25,6 W CRI>90
3000 K – 3200 NOMINAL LM

DIMM 1-10V + PUSH

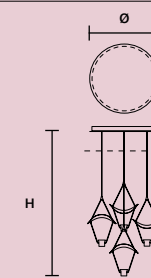

VOLLEE C8P RD 80

ø 80 cm / 31.49"
H 200 cm / 78.74"

INTEGRATED LED LIGHTING

52,8 W CRI>90
3000 K – 6600 NOMINAL LM

DIMM 1-10V + DALI + PUSH

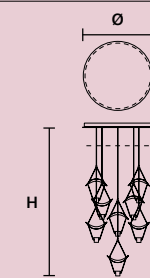

VOLLEE C4 G

INTEGRATED LED LIGHTING

25,6 W CRI>90
3000 K – 3200 NOMINAL LM

DIMM 1-10V + PUSH

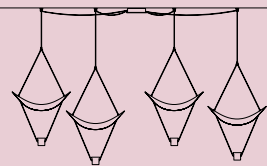

VOLLEE C2+2

INTEGRATED LED LIGHTING

25,6 W CRI>90
3000 K – 3200 NOMINAL LM

DIMM 1-10V + PUSH

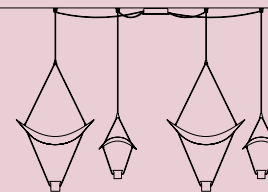

VOLLEE C5 P

INTEGRATED LED LIGHTING

31 W CRI>90
3000 K – 3900 NOMINAL LM

DIMM 1-10V + DALI + PUSH

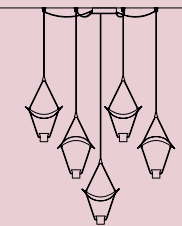

VOLLEE C2G LN 75

L 75 cm / 29.52"
SP 20 cm / 7.87"
H MAX 240 cm / 94.48"

INTEGRATED LED LIGHTING

12,8 W CRI>90
3000 K – 1600 NOMINAL LM

DIMM 1-10V + PUSH

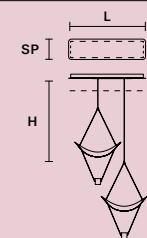

VOLLEE C4P LN 125

L 125 cm / 49.21"
SP 20 cm / 7.87"
H MAX 200 cm / 78.74"

INTEGRATED LED LIGHTING

25,6 W CRI>90
3000 K – 3200 NOMINAL LM

DIMM 1-10V + PUSH

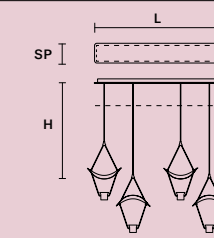

For the US market, refer to
the relevant price list.

SUGGESTED CONFIGURATION FOR C4 G

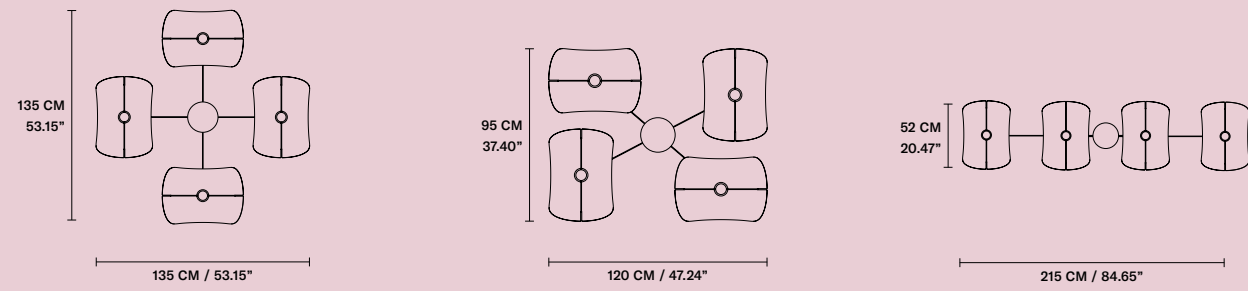

SUGGESTED CONFIGURATION FOR C 2+2

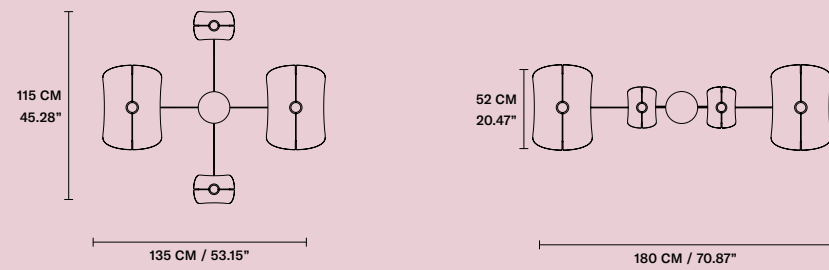

SUGGESTED CONFIGURATION FOR C5 P

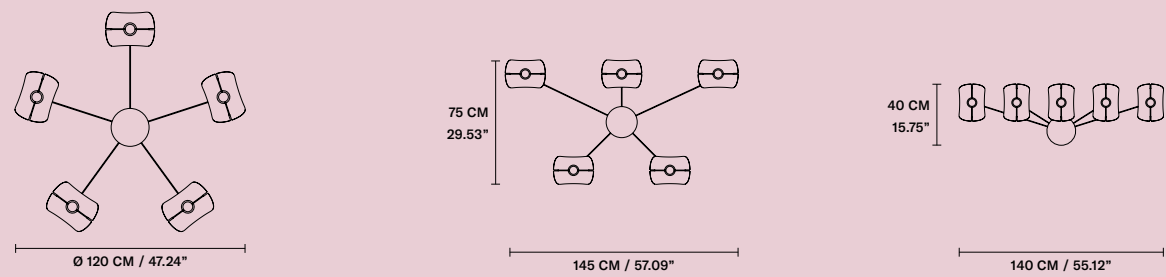

SUGGESTED CONFIGURATION FOR C5 P X4

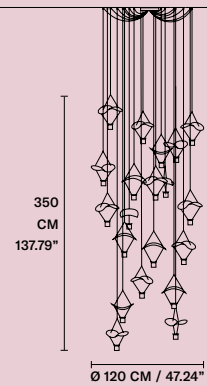

Technical info



Finishings

VERNICIATURA OPACA MATT PAINTED

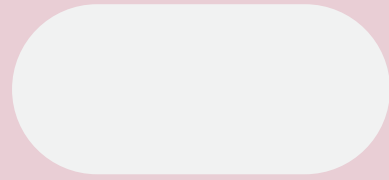

v95 Bianco opaco
Matt white



v24 Zucca
Pumpkin



v51 Celeste
Pale blue



v21 Sabbia
Sand

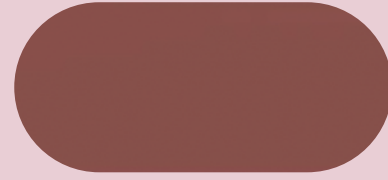

v30 Rosso ossido
Oxide red



v55 Carta da zucchero
Mid Blue



v70 Cemento
Concrete

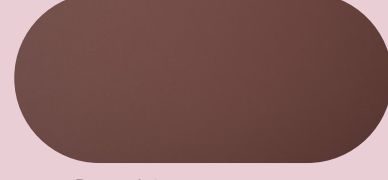

v35 Rosso Jaipur
Jaipur red



v50 Blu navy
Navy Blue

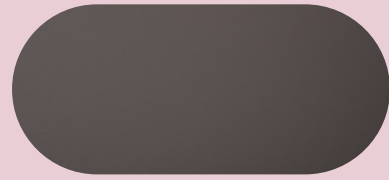

v84 Cioccolato
Chocolate



v83 Bronzo
Bronze



v60 Verde ottanio
Ottanio green



v72 Grigio scuro
Dark grey



v99 Oro opaco verniciato
Painted matt gold

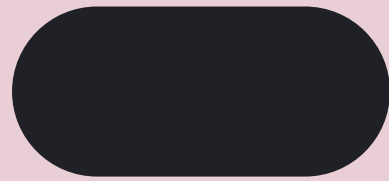

v90 Nero opaco
Matt black

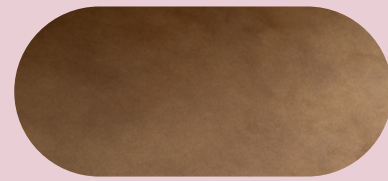

v86 Bronzo patinato
Coated bronze

Verificare la disponibilità
di ciascuna finitura
per specifici articoli.

Availability of each
finish to be confirmed
for specific items.

VERNICIATURA GOFFRATA EMBOSSED PAINTED



v98 Bianco goffrato
Embossed white

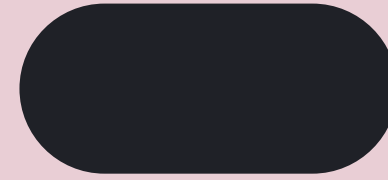

v91 Nero goffrato
Embossed Black

VERNICIATURA LUCIDA GLOSSY PAINTED



v87 Cioccolato fondente
Foundant Chocolate

Verificare la disponibilità
di ciascuna finitura
per specifici articoli.

Availability of each
finish to be confirmed
for specific items.

Finishings

BAGNO GALVANICO GALVANIC BATH



G03 Oro lucido
Shiny gold



G01 Brunito
Burnished

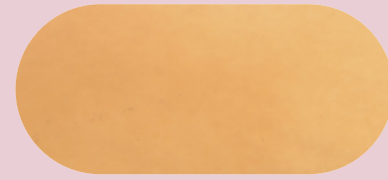

G25 Rame dorato
Golden copper



G05 Oro opaco
Matt gold



G04 Cromo lucido
Shiny chrome

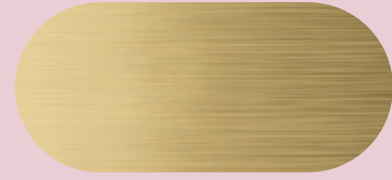

G12 Oro spazzolato
Brushed gold

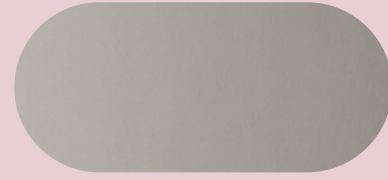

G06 Cromo opaco
Matt chrome



G14 Ottone brunito
Burnished brass



G07 Nickel spazzolato
Brushed nickel



G18 Ottone spazzolato
Brushed brass



G22 Oro
Pure gold



G23 Nickel Scuro
Dark nickel

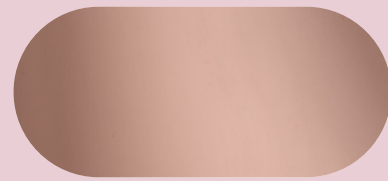

G24 Oro rosa
Rose gold

Verificare la disponibilità
di ciascuna finitura
per specifici articoli.

Availability of each
finish to be confirmed
for specific items.

DECORAZIONE A FOGLIA LEAF DECORATION

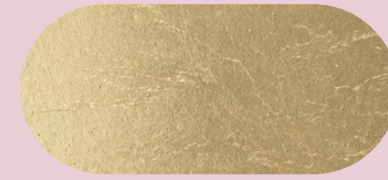

F01 Foglia oro
Gold leaf



F02 Foglia argento
Silver leaf



F03 Foglia rame
Copper leaf



F04 Foglia champagne
Champagne leaf

FINITURE LEGNO WOOD FINISHING



W01 Rovere



W04 Pale oak



W05 Walnut



W06 Grey ayous



W07 Black&silver



W03 Wengé

ECOPELLE ECO LEATHER



L02 Ecopelle 2
Eco Leather 2



L03 Ecopelle 3
Eco Leather 3

Verificare la disponibilità
di ciascuna finitura
per specifici articoli.

Availability of each
finish to be confirmed
for specific items.

General informations



Attesta la conformità del prodotto alle disposizioni delle Direttive comunitarie.

It certifies the conformity of the products to the European Community provisions.

Konformität des Produktes mit den Richtlinien der europäischen Gemeinschaft.

Certifica la conformidad del producto según las disposiciones de las directivas comunitarias.

Il atteste la conformité du produit aux dispositions des directives communitaires.

Настоящим подтверждается соответствие продукции положениям директив ес.

CE 标记是指产品的制造商证明该产品符合适用的EC指令的所有基本要求.

يُشهد بمطابقة المنتج لأحكام توجيهات الاتحاد الأوروبي.



Il logo “ETL” si riferisce agli articoli che possono essere modificati con componenti certificati ETL. L'elenco degli articoli ETL si riferisce a prodotti testati e valutati in base agli standard di sicurezza del mercato statunitense. Per il mercato USA fare riferimento al listino dedicato.

“ETL” logos refers to articles which can be modified with ETL-compliance components. The “ETL” listing articles stands for tested and evaluated product to recognised US safety standards. For the US market, refer to the relevant price list.

Das "ETL"-Logo bezieht sich auf Artikel, die mit ETL-zertifizierten Komponenten modifiziert werden können. Die Liste der ETL-Artikel bezieht sich auf Produkte, die nach den Sicherheitsstandards des US-Marktes getestet und bewertet wurden. Für den US-Markt beachten Sie bitte die entsprechende Preisliste.

El logo “ETL” indica los artículos, que pueden modificarse con componentes certificados ETL. La lista de los artículos ETL se refiere a los productos sometidos a prueba y evaluados en función de los estándares de seguridad del mercado estadounidense. Consultar la lista de precios específica para el mercado de los Estados Unidos.

“ETL” logo se réfère aux articles qui peuvent être modifiées par des composants certifiés ETL. la liste des articles ETL se réfère à des produits testés et évalués selon les normes de sécurité du marché américain. Pour le marché américain se référer à la liste des prix.

логотип «ETL» относится к элементам, которые могут быть модифицированы спомощью сертифицированных ETL компонентов. список элементов eTL относится к продукции, протестированной и оцененной в соответствии с признанными стандартами безопасности США. для потребителей Находящихся в США см. соответствующий прайс-лист.

“ETL” 徽标是指可以使用ETL认证的组件进行修改的项目。 ETL项目列表是指根据美国市场的安全标准进行测试和评估的产品。 对于美国市场，请参考美国市场价格表。

يشير شعار "ETL" إلى المنتجات التي يمكن تعديلها باستخدام مكونات مُعتمدة من ETL. تشير قائمة منتجات ETL إلى المنتجات التي تم اختبارها وتقييمها وفقًا لمعايير السلامة في السوق الأمريكي. بالنسبة لسوق الولايات المتحدة الأمريكية، يُرجى الرجوع إلى قائمة الأسعار المُخصصة.



CCC sta per China Compulsory Certificate, una certificazione di prodotto obbligatoria richiesta per determinati prodotti destinati al mercato cinese.

CCC stands for China Compulsory Certificate, a mandatory product certification required for certain products meant to the Chinese market.

CCC steht für China Compulsory Certificate, eine obligatorische Produktzertifizierung, die für bestimmte Produkte erforderlich ist, die für den chinesischen Markt bestimmt sind.

CCC significa China Compulsory Certificate, una certificación de producto obbligatoria requerida para ciertos productos destinados al mercado chino.

CCC signifie China Compulsory Certificate, une certification de produit obligatoire requise pour certains produits destinés au marché chinois.

CCC расшифровывается как China Compulsory Certificate, обязательная сертификация необходимая для определенных продуктов, предназначенных для внутреннего рынка Китая.

认证的全称为“中国强制性产品认证”，英文名称China Compulsory Certification, 英文缩写CCC。这种认证是针对某些面向中国市场的产品所必需的强制性产品认证。

يرمز CCC إلى الشهادة الإلزامية الصينية، وهي شهادة اعتماد منتج إلزامية مطلوبة لبعض المنتجات المخصصة للسوق الصينية.



Lo schema IECEE CB è un sistema internazionale per l'accettazione reciproca di rapporti di prova e certificati relativi alla sicurezza di componenti, apparecchiature e prodotti elettrici ed elettronici operative e dei prodotti sulla base di un accordo multilaterale tra i paesi partecipanti e gli organismi di certificazione.

IECEE CB is an international system for the mutual acceptance of test reports and certificates of the safety of components, operational electrical and electronic equipment and products on the basis of a multilateral agreement between participating countries and certification bodies.

Das IECEE CB Schema ist ein internationales System zur gegenseitigen Anerkennung von Testberichten und Zertifikaten bezüglich der Sicherheit von Komponenten, betriebsbereite Geräte und Produkte auf der Grundlage eines multilateralen Abkommens zwischen teilnehmenden Ländern und Zertifizierungsstellen.

IECEE CB es un sistema internacional para la aceptación mutua de informes de ensayo y certificados de seguridad de componentes, equipos y productos eléctricos y electrónicos operativos y de productos, sobre la base de un acuerdo multilateral entre los países participantes y los organismos de certificación.

Le système IECEE CB est un système international d'acceptation mutuelle des rapports d'essai et des certificats de sécurité des composants, équipements et produits électriques et électroniques opérationnels et des produits, sur la base d'un accord multilatéral entre les pays participants et les organismes de certification.

Схема IECEE CB представляет собой международную систему взаимного признания сертификатов и отчетов об испытаниях, касающихся безопасности электрических и электронных компонентов и оборудования, основанную на многостороннем соглашении между странами-участницами и органами по сертификации.

认证是电工产品测试证书互认体系（CB 体系） 是国际电工委员会电工产品合格测试与认证组织。

مخطط IECEE CB هو نظام دولي للقبول المتبادل لتقارير الاختبار والاعتمادات المتعلقة بسلامة المكونات، والمعدات، والمنتجات الكهربائية والإلكترونية التشغيلية والمنتجات بناءً على اتفاقية متعددة الأطراف بين الدول المشاركة وهيئات الاعتماد.

Im

Flusso luminoso nominale. L'indicazione si riferisce al valore in assenza di rifrazione, come dichiarato dal produttore del componente.

Nominal luminous flux. It refers to the value without any refraction, as declared by the component manufacturer.

Die Masseinheit für den Lichtstrom. Die Angabe bezieht sich auf den Wert in der Abwesenheit von Brechung, wie vom Hersteller der Komponente angegeben.

Flujo luminoso nominal. La indicación se refiere al valor sin refracción, como declarado por el fabricante del componente.

L'unité SI de flux lumineux. L'indication corresponds à la valeur en l'absence de réfraction, comme indiqué par le fabricant du composant.

Номинальный световой поток. указание относится к значению в отсутствие рефракции, как заявлено производителем компонента.

标称光通量。指示是指组件制造商声明的没有折射的值。

التدفق الضوئي الاسمي.يشير المؤشر إلى القيمة في حالة عدم وجود انكسار للضوء، كما هو مُعلن من قبل الشركة المصنعة للعنصر.

MASIERO

Masiero si riserva il diritto di apportare ai propri articoli, senza nessun preavviso, qualsiasi modifica ritenesse opportuna.

Masiero reserves the right to introduce any changes to its own products, without notice in advance.

Masiero behalt sich das Recht vor nderungen vorzunehmen, ohne sofortige Benachrichtigung.

Masiero se reserva el derecho de aportar modificaciones consideradas oportunas a sus artculos sin preaviso.

Masiero se rserve le droit d'apporter une quelconque modification  les modles sans pravis.

компания Masiero оставляет за собой право без предварительного уведомления, если это будет сочтено целесообразным, вносить в собственные модели любые изменения.

Masiero 保留对其认为适当的任何更改的权利，恕不另行通知。

تحتفظ شركة مازيرو "Masiero" بالحق في إجراء أي تعديلات تراها مناسبة على منتجاتها، دون إشعار مسبق.

ART DIRECTION, DESIGN
Designwork

LAYOUT
Masiero

PHOTO, REPRO
Loris Casonato

DIREZIONE ARTISTICA FOTOGRAFICA, STYLING
NOOII

PRINT
Italy, March 2023
by Grafica Antiga

Masiero srl

via Peschiere, 53
31032 Casale sul Sile
Treviso, Italy
T +39 0422 7861
F +39 0422 786250

info@masierogroup.com
masierogroup.com

Masiero USA LTD

100 Park Avenue,
Suite 1600
New York, NY 10017
T +1 212 4666754

sales@masiero-usa.com
masiero-usa.com

THANKS TO

Alessandra Salaris
Doimo Salotti
Miniform
Saba
Trabà



